



ALUMINUM

EXTERIOR

GUIDE NO. 8

イナバ製作所 代理店

(エクステリア資材・アルミ長尺型材・網戸・面格子・ベランダ手摺 卸販売)

株式会社 **キョーリツ** 製作所

イナバ物置



やっぱりイナバ

100人
乗っても

大丈夫!

高知県正規代理店
卸販売専門
組立工事も承ります

目 次

(アルミ型材) 1～35 P

角パイプ	1～ 7 P
Lアングル	8～12 P
フラットバー	13～16 P
チャンネル	16～19 P
Zアングル、水切り	19～20 P
丸パイプ	20～23 P
テラス、バルコニー	23～27 P
階段	27 P
ビスホール付角パイプ	28～29 P
手摺	29～32 P
面格子、クロス格子	32～34 P
門扉	33～34 P
網戸	34 P

(各種部品) 36～42 P

テラス	36 P
ビス、アンカーボルト、リベット	36～37 P
網戸、ネット	37～38 P
面格子、クロス格子	38～39 P
手摺、門扉	39～40 P
キャップ	40～42 P
カットLアングル	42 P

(納まり図、定価表、その他) 43～75 P

網戸張り替え	43～45 P
オーダー網戸	46～53 P
フクロ網戸	54 P
固定網戸	55 P
オーダー面格子	56～60 P
ビル用面格子	61 P
クロス格子・井桁格子	62～63 P
四方枠立格子	64～65 P
へダテ	66 P
オーダー門扉	67 P
納骨堂取替え用扉	68 P
B L窓手摺	69 P
手摺	70～71 P
パンチング	72～74 P
オーダー製作品集	75 P

【アルミ型材製品掲載のご案内】

- ◎ 在庫品と取寄品がありますので、納期をご確認の上、ご注文下さい。
- ◎ ご注文は必ずFAXにて明確にお願いいたします。
- ◎ 商品は店頭渡し価格です。原則として配達は致しません。（但し便が有る場合配達します）
- ◎ 商品の発送については在庫が有れば当日、若しくは翌日発送いたします。
- ◎ 梱包、運送費は別途いただきます。
- ◎ ロット発注の場合は特別価格にて見積もりさせていただきます。
- ◎ 予告なく商品の仕様、価格の変更及び廃止する場合がありますので、ご了承ください。
- ◎ 表示価格には消費税、工事費は含まれていません。

〈型材のカット販売について〉

- ◎ 無印の型材はご希望のサイズにてカット販売いたします（定価の10% u p）
- ◎ ⊗印はカット販売出来ません。（但し、端材がある場合を除きます）
- ◎ ⊕印は半分カット販売いたします。（定価の5%UP）

〈カラーバリエーション記号〉

S シルバー	K ブラック	W ホワイト
B ブロンズ	SC ステンカラー	AB オータムブラウン
DB ダークブロンズ	※AB色のキャップはブロンズ色となります	

※カタログに掲載されていない型材も多数取り扱いいたしておりますので
お気軽にお問合せください。

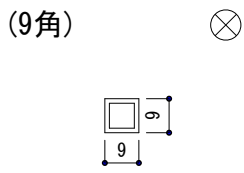
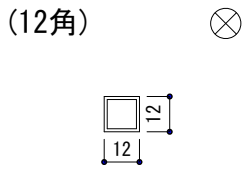
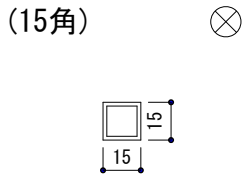
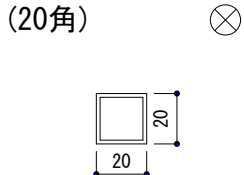
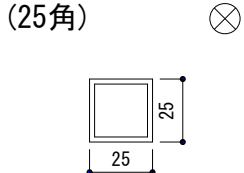
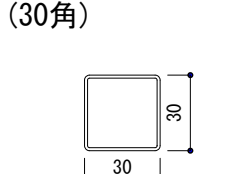
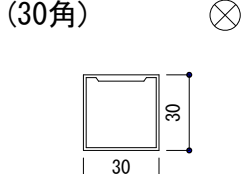
No.	製品型図	①長さ ②厚さ ③型番	色	定価	用途
1	(9角) 	① 5,000 ② 1.2 ③ N0-1071	S B K	¥ 2,000 ¥ 2,100 ¥ 2,200	
2	(12角) 	① 5,000 ② 1.2 ③ N0-1072	S B K	¥ 2,800 ¥ 2,900 ¥ 3,000	
3	(15角) 	① 5,000 ② 1.2 ③ N0-1073	S B K SC AB	¥ 3,500 ¥ 3,600 ¥ 3,800 ¥ 4,200 ¥ 4,200	キャップ有
4	(20角) 	① 5,000 ② 1.5 ③ N0-1076	S B K SC AB	¥ 5,800 ¥ 6,000 ¥ 6,400 ¥ 6,900 ¥ 6,900	キャップ有
5	(25角) 	① 5,000 ② 2.0 ③ N0-1079	S B K SC AB	¥ 9,600 ¥ 10,000 ¥ 10,600 ¥ 11,400 ¥ 11,400	キャップ有
6	(30角) 	① 5,500 ② 1.2 ③ KM-396	SC	¥ 6,200	全面ライン有 キャップ有 在庫限り
7	(30角) 	① 5,770 ② 1.1 ③ N0-240	S B W K	¥ 8,300 ¥ 8,600 ¥ 9,400 ¥ 9,700	キャップ有

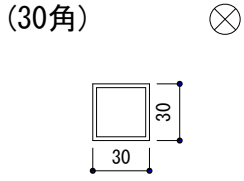
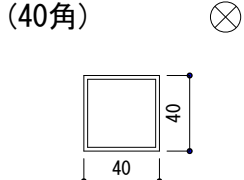
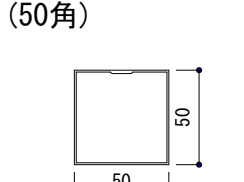
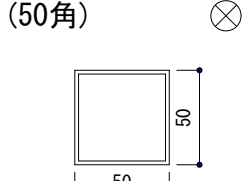
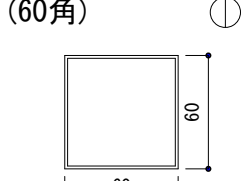
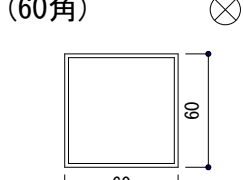
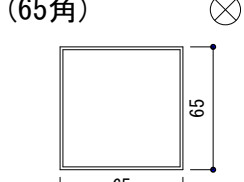
No.	製品型図	①長さ ②厚さ ③型番	色	定価	用途
8	(30角) 	① 5,000 ② 2.0 ③ N0-1081	S B K SC AB	¥ 11,600 ¥ 12,300 ¥ 12,900 ¥ 14,000 ¥ 14,000	キャップ有
9	(40角) 	① 5,000 ② 2.0 ③ N0-1083	S B K SC AB	¥ 15,800 ¥ 16,500 ¥ 17,400 ¥ 18,900 ¥ 18,900	キャップ有
10	(50角) 	① 5,500 ② 1.2 ③ N0-528 IC-076	S B K SC	¥ 8,400 ¥ 9,100 ¥ 12,400 ¥ 9,700	キャップ有 K色のみ L=5330
11	(50角) 	① 5,000 ② 2.0 ③ N0-1085	S B K SC	¥ 19,500 ¥ 20,500 ¥ 21,700 ¥ 23,400	キャップ有
12	(60角) 	① 5,800 ② 1.5 ③ N0-261 U-5564	S B W K SC	¥ 16,000 ¥ 14,900 ¥ 19,000 ¥ 20,100 ¥ 15,800	S・W・K色のみ L=6000 キャップ有
13	(60角) 	① 5,000 ② 2.0 ③ N0-1088	S B K SC	¥ 22,900 ¥ 24,000 ¥ 25,400 ¥ 27,500	キャップ有
14	(65角) 	① 6,000 ② 1.5 ③ N0-533	S B K SC	¥ 19,200 ¥ 20,100 ¥ 23,200 ¥ 23,600	キャップ有

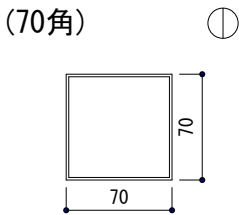
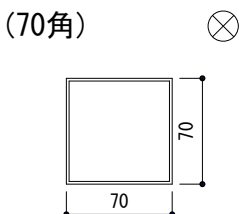
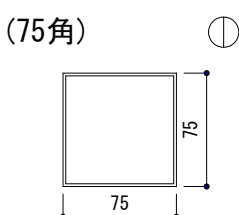
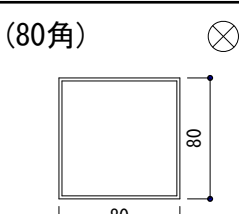
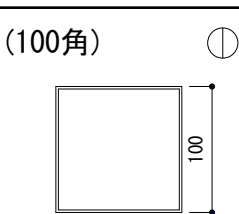
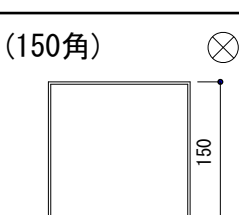
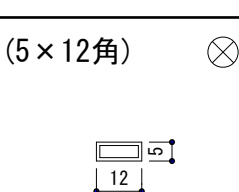
No.	製品型図	①長さ ②厚さ ③型番	色	定価	用途
15	(70角) 	① 5,800 ② 1.7 ③ U-6434	S B SC	¥ 20,400 ¥ 22,100 ¥ 23,400	テラス柱 キャップ有
16	(70角) 	① 6,000 ② 1.8 ③ N0-535	S B W K SC AB	¥ 23,300 ¥ 25,700 ¥ 28,000 ¥ 29,000 ¥ 29,500 ¥ 30,400	キャップ有
17	(75角) 	① 6,000 ② 1.8 ③ N0-536 J-8119	S B W K SC	¥ 23,200 ¥ 25,100 ¥ 27,500 ¥ 28,500 ¥ 26,600	キャップ有
18	(80角) 	① 5,000 ② 2.0 ③ N0-1090	S B K	¥ 29,200 ¥ 30,600 ¥ 32,500	テラス柱 キャップ有
19	(100角) 	① 6,000 ② 1.8 ③ N0-537	S B W K	¥ 33,300 ¥ 35,200 ¥ 38,900 ¥ 40,700	大型テラス柱 キャップ有
20	(150角) 	① 6,000 ② 2.5 ③ N0-538	S B W K	¥ 64,100 ¥ 68,600 ¥ 74,200 ¥ 79,100	
21	(5×12角) 	① 4,000 ② 0.9 ③ N0-504	S B W K	¥ 1,200 ¥ 1,300 ¥ 1,400 ¥ 1,500	

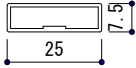
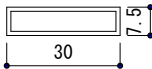
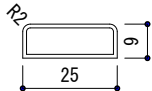
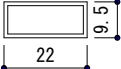
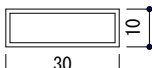
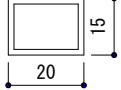
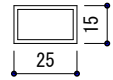

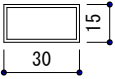
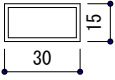
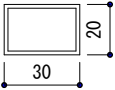
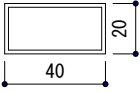
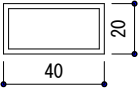
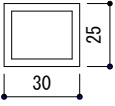
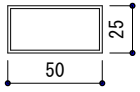
No.	製品型図	①長さ ②厚さ ③型番	色	定価	用途
22	(7.5×25角) 	① 4,000 ② 1.1 ③ UF-139	B SC	¥ 2,200 ¥ 2,500	在庫限り
23	(7.5×30角) ⊗ 	① 5,500 ② 1.0 ③ N0-507	S B	¥ 3,400 ¥ 3,600	
24	(9×25角) ⊗ 	① 5,500 ② 1.0 ③ N0-542	S B W K SC AB	¥ 3,600 ¥ 4,000 ¥ 4,300 ¥ 4,300 ¥ 4,800 ¥ 4,800	クロス格子 マスク格子
25	(9.5×22角) ⊗ 	① 5,500 ② 1.0 ③ N0-541	B K	¥ 3,300 ¥ 3,800	
26	(10×30角) ⊗ 	① 5,500 ② 1.2 ③ N0-508	S B W K SC	¥ 4,000 ¥ 4,300 ¥ 4,600 ¥ 4,800 ¥ 4,900	
27	(15×20角) ⊗ 	① 5,500 ② 1.5 ③ N0-506	S B W K SC	¥ 4,700 ¥ 4,900 ¥ 5,300 ¥ 5,400 ¥ 5,700	キャップ有
28	(15×25角) ⊗ 	① 5,000 ② 1.5 ③ N0-1111	S B K SC AB	¥ 5,900 ¥ 6,100 ¥ 6,500 ¥ 7,000 ¥ 7,000	キャップ有

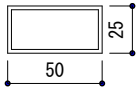
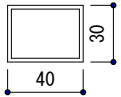
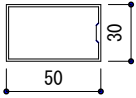
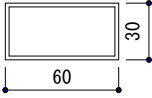
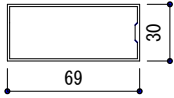
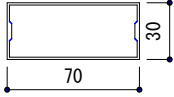
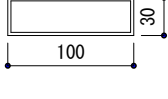

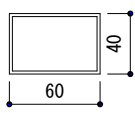
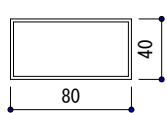
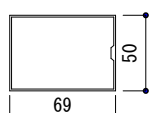
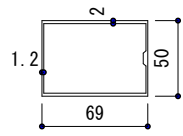
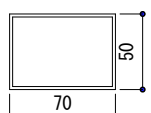
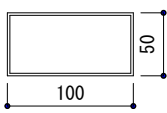
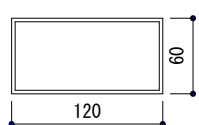
No.	製品型図	①長さ ②厚さ ③型番	色	定価	用途
29	(15×30角) ⊗ 	① 5,500 ② 1.2 ③ N0-509	S B K	¥ 4,800 ¥ 5,000 ¥ 5,600	キャップ有
30	(15×30角) ⊗ 	① 5,000 ② 1.5 ③ N0-1112	S B K SC AB	¥ 6,600 ¥ 6,900 ¥ 7,400 ¥ 8,000 ¥ 8,000	キャップ有
31	(20×30角) ⊗ 	① 5,000 ② 1.5 ③ N0-1114	S B K SC AB	¥ 7,300 ¥ 7,600 ¥ 8,100 ¥ 8,700 ¥ 8,700	キャップ有
32	(20×40角) ⊗ 	① 5,500 ② 1.5 ③ N0-514	S B W K SC	¥ 8,400 ¥ 9,000 ¥ 9,800 ¥ 10,700 ¥ 9,800	キャップ有
33	(20×40角) ⊗ 	① 5,000 ② 2.0 ③ N0-1116	S B K SC AB	¥ 11,700 ¥ 12,200 ¥ 12,900 ¥ 14,000 ¥ 14,000	キャップ有
34	(25×30角) ⊗ 	① 5,000 ② 3.0 ③ N0-1117	S B K	¥ 15,000 ¥ 15,700 ¥ 16,700	キャップ有
35	(25×50角) ⊗ 	① 5,500 ② 1.5 ③ N0-520	S B K	¥ 9,100 ¥ 9,700 ¥ 11,100	キャップ有

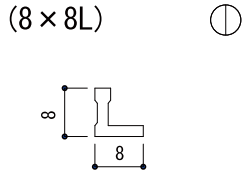
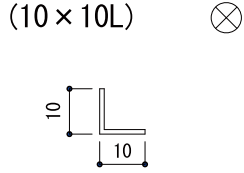
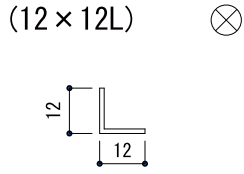
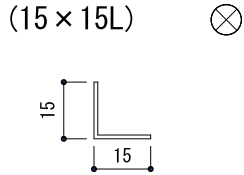
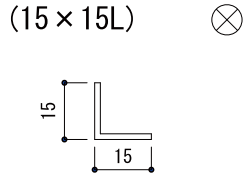
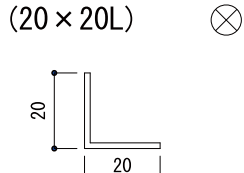
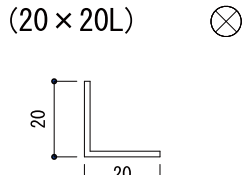
No.	製品型図	①長さ ②厚さ ③型番	色	定価	用途
36	(25×50角) ⊗ 	① 5,000 ② 2.0 ③ N0-1118	S B K SC AB	¥ 14,700 ¥ 15,400 ¥ 16,300 ¥ 17,900 ¥ 17,900	キャップ有
37	(30×40角) ⊗ 	① 5,000 ② 2.0 ③ N0-1120	S B K SC	¥ 13,700 ¥ 14,300 ¥ 15,100 ¥ 16,400	キャップ有
38	(30×50角) 	① 5,410 ② 1.1 ③ N0-526	S B W K	¥ 7,400 ¥ 7,800 ¥ 8,500 ¥ 8,900	S色 L=5500 有 キャップ有
39	(30×60角) ⊗ 	① 5,000 ② 2.0 ③ N0-1122	S B K SC	¥ 17,900 ¥ 18,700 ¥ 19,700 ¥ 21,300	キャップ有
40	(30×69角) ⊗ 	① 5,350 ② 1.1 ③ N0-527	S B W K SC AB	¥ 10,300 ¥ 10,800 ¥ 11,800 ¥ 12,200 ¥ 12,400 ¥ 12,400	キャップ有
41	(30×70角) ⊗ 	① 5,800 ② 1.3 ③ KN-024	B SC	¥ 12,900 ¥ 13,700	キャップ有 在庫限り
42	(30×100角) ⊗ 	① 5,000 ② 2.5 ③ N0-1125	S B K	¥ 29,000 ¥ 30,500 ¥ 32,200	キャップ有

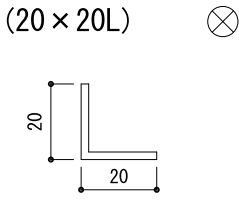
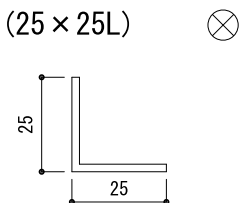
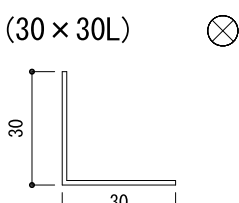
No.	製品型図	①長さ ②厚さ ③型番	色	定価	用途
43	(40×60角) ⊗ 	① 5,000 ② 2.0 ③ N0-1126	S B K SC	¥ 19,100 ¥ 20,100 ¥ 21,200 ¥ 22,800	キャップ有
44	(40×80角) ⊗ 	① 5,000 ② 2.0 ③ N0-1129	S B K SC	¥ 22,900 ¥ 23,900 ¥ 25,400 ¥ 27,500	キャップ有
45	(50×69角) ⊗ 	① 5,350 ② 1.2 ③ N0-529	B W K SC AB	¥ 14,400 ¥ 15,800 ¥ 16,300 ¥ 16,600 ¥ 16,600	キャップ有
46	(50×69角) ⊗ 	① 5,940 ② 2.0 1.2 ③ N0-530	B W K SC AB	¥ 20,800 ¥ 22,700 ¥ 23,400 ¥ 23,900 ¥ 25,800	キャップ有
47	(50×70角) ⊗ 	① 5,000 ② 2.0 ③ N0-1133	S B K	¥ 21,700 ¥ 22,800 ¥ 24,100	キャップ有
48	(50×100角) ⊗ 	① 5,500 ② 1.8 ③ N0-539	S B W K SC	¥ 27,000 ¥ 28,700 ¥ 30,500 ¥ 30,500 ¥ 30,500	キャップ有
49	(60×120角) ⊗ 	① 5,000 ② 2.8 ③ N0-1137	S B K	¥ 45,400 ¥ 47,600 ¥ 50,400	アルミキャップ有

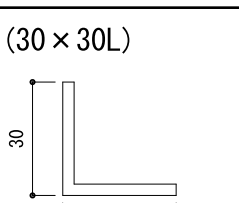
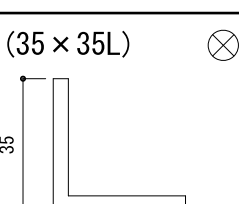
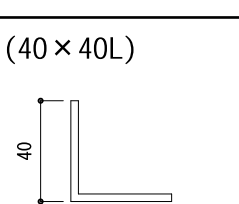
No.	製品型図	①長さ ②厚さ ③型番	色	定価	用途
50	(8×8L) 	① 4,000 ② 1.8 ③ N0-464	S B	¥ 1,800 ¥ 1,800	
51	(10×10L) 	① 4,000 ② 1.2 ③ N0-1002	S B K	¥ 1,100 ¥ 1,100 ¥ 1,100	
52	(12×12L) 	① 4,000 ② 1.2 ③ N0-1003	S B K	¥ 1,400 ¥ 1,400 ¥ 1,400	
53	(15×15L) 	① 4,000 ② 1.0 ③ N0-1004	S B K	¥ 1,300 ¥ 1,400 ¥ 1,400	
54	(15×15L) 	① 4,000 ② 1.5 ③ N0-1005	S B W K SC AB	¥ 1,600 ¥ 1,700 ¥ 1,800 ¥ 1,900 ¥ 2,100 ¥ 2,100	
55	(20×20L) 	① 4,000 ② 1.2 ③ N0-472	S B W K	¥ 1,600 ¥ 1,700 ¥ 1,800 ¥ 2,000	
56	(20×20L) 	① 4,000 ② 1.5 ③ N0-1010	S B K	¥ 2,000 ¥ 2,100 ¥ 2,200	

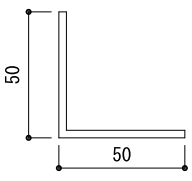
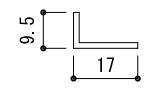
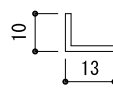
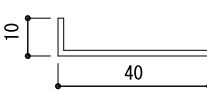
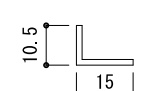
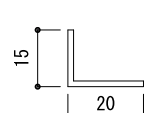
No.	製品型図	①長さ ②厚さ ③型番	色	定価	用途
57	(20×20L) 	① 4,000 ② 2.0 ③ N0-1011	S B K SC AB	¥ 3,200 ¥ 3,400 ¥ 3,600 ¥ 3,800 ¥ 3,800	
58	(25×25L) 	① 4,000 ② 2.0 ③ N0-1015	S B K SC AB	¥ 4,000 ¥ 4,200 ¥ 4,400 ¥ 4,800 ¥ 4,800	
59	(30×30L) 	① 4,000 ② 1.2 ③ N0-474	S B W K	¥ 2,300 ¥ 2,500 ¥ 3,000 ¥ 3,300	
60	(30×30L) 	① 4,000 ② 2.0 ③ N0-1020	S B K SC AB	¥ 4,800 ¥ 5,100 ¥ 5,300 ¥ 5,700 ¥ 5,700	
61	(30×30L) 	① 4,000 ② 3.0 ③ N0-1021 N0-475	S B W K SC AB	¥ 5,400 ¥ 5,900 ¥ 8,500 ¥ 6,800 ¥ 6,200 ¥ 7,300	W色のみ L = 5500
62	(35×35L) 	① 4,000 ② 4.0 ③ N0-1025	S B K	¥ 10,400 ¥ 10,900 ¥ 11,700	
63	(40×40L) 	① 5,500 ② 3.0 ③ N0-1026 N0-481	S B W K SC AB	¥ 9,900 ¥ 10,700 ¥ 11,500 ¥ 12,200 ¥ 9,800 ¥ 9,800	SC・AB色のみ L = 4000

No.	製品型図	①長さ ②厚さ ③型番	色	定価	用途
64	(50×50L) 	① 5,500 ② 3.0 ③ MY-102 N0-1030	S B K SC AB	¥ 11,000 ¥ 12,500 ¥ 13,100 ¥ 13,500 ¥ 12,200	AB色のみ L=4000
65	(9.5×17L) ⊕ 	① 4,000 ② 1.5 ③ N0-469	S B W	¥ 1,800 ¥ 2,200 ¥ 2,200	網戸上レール
66	(10×13L) ⊕ 	① 4,000 ② 1.5 ③ N0-465	S B	¥ 1,600 ¥ 1,600	網戸下レール
67	(10×40L) ⊗ 	① 4,000 ② 1.5 ③	S	¥ 2,600	
68	(10.5×15L) ⊕ 	① 4,000 ② 1.5 ③ N0-466	S B	¥ 1,700 ¥ 1,700	
69	(15×20L) ⊗ 	① 4,000 ② 1.5 ③ N0-471 N0-1041	S B W K SC AB	¥ 1,700 ¥ 1,800 ¥ 1,900 ¥ 2,200 ¥ 2,200 ¥ 2,400	
70	(15×25L) ⊗ 	① 4,000 ② 1.5 ③ N0-1043	S B K	¥ 2,400 ¥ 2,600 ¥ 2,700	

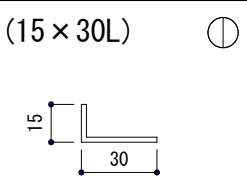
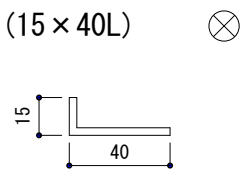
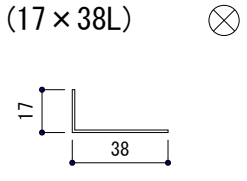
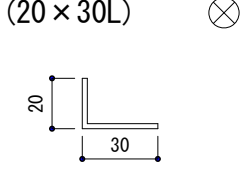
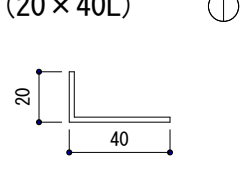
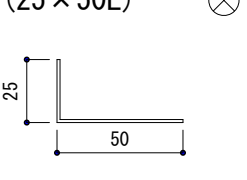
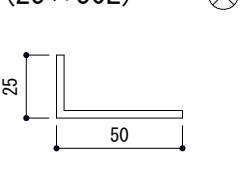

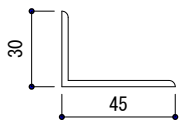
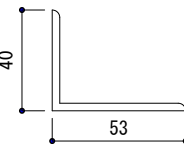
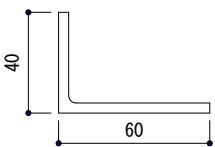
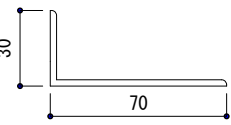
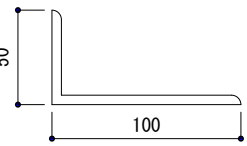
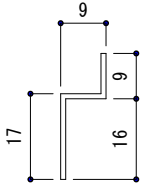
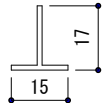
No.	製品型図	①長さ ②厚さ ③型番	色	定価	用途
71	(15×30L)  ①	① 4,000 ② 2.0 ③ N0-1045	S B K SC AB	¥ 3,300 ¥ 3,400 ¥ 3,600 ¥ 3,900 ¥ 3,900	
72	(15×40L)  ⊗	① 4,000 ② 3.0 ③ N0-477	S B W K SC AB	¥ 5,100 ¥ 5,400 ¥ 5,900 ¥ 6,100 ¥ 6,500 ¥ 6,500	
73	(17×38L)  ⊗	① 4,000 ② 1.0 ③ N0-473	B	¥ 2,200	
74	(20×30L)  ⊗	① 4,000 ② 2.0 ③ N0-1046	S B K SC AB	¥ 4,200 ¥ 4,200 ¥ 4,400 ¥ 4,800 ¥ 4,800	
75	(20×40L)  ①	① 4,000 ② 2.0 ③ N0-1048	S B W K SC AB	¥ 3,800 ¥ 4,000 ¥ 4,300 ¥ 4,700 ¥ 5,100 ¥ 5,100	
76	(25×50L)  ⊗	① 4,000 ② 1.2 ③ N0-479	S B K	¥ 3,200 ¥ 3,300 ¥ 4,100	
77	(25×50L)  ⊗	① 4,000 ② 3.0 ③ N0-1050	S B K SC AB	¥ 8,900 ¥ 9,300 ¥ 10,000 ¥ 10,700 ¥ 10,700	

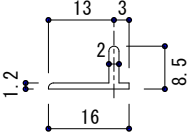
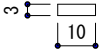
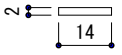
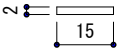
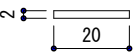
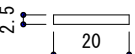
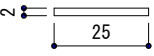
No.	製品型図	①長さ ②厚さ ③型番	色	定価	用途
78	(30×45L) 	① 5,500 ② 2.5 ③ N0-480	S B W K	¥ 8,600 ¥ 9,200 ¥ 9,800 ¥ 10,100	R付
79	(40×53L) 	① 5,500 ② 3.0 ③ N0-482	S B W K SC AB	¥ 11,300 ¥ 12,200 ¥ 13,100 ¥ 13,500 ¥ 13,900 ¥ 14,800	R付
80	(40×60L) 	① 5,500 ② 4.0 ③ N0-484	S B W K	¥ 16,300 ¥ 17,100 ¥ 18,700 ¥ 19,200	内側R付ライン有
81	(30×70L) 	① 5,500 ② 2.5 ③ N0-483	S B W K SC	¥ 10,800 ¥ 11,600 ¥ 12,400 ¥ 12,900 ¥ 14,200	R付
82	(50×100L) 	① 5,500 ② 5.0 ③ N0-485	S B W K SC	¥ 29,800 ¥ 31,300 ¥ 33,600 ¥ 36,900 ¥ 33,600	R付
83	(Z型レール) ① 	① 4,000 ② 1.5 ③ N0-468	S B	¥ 1,700 ¥ 1,700	網戸レール
84	(T型レール) ② 	① 4,000 ② 1.3 ③ N0-467	S B	¥ 1,700 ¥ 1,700	網戸レール

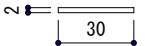
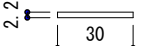
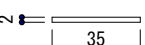
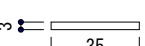
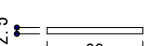
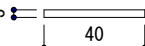
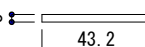

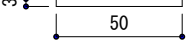
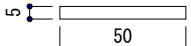
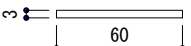
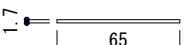
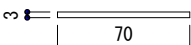
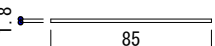
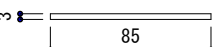
No.	製品型図	①長さ ②厚さ ③型番	色	定価	用途
85	(T型レール) ⊙ 	① 4,000 ② ③	S B	¥ 3,000 ¥ 3,000	網戸下レール
86	(フラットバー10巾) ⊗ 	① 4,000 ② 3.0 ③ N0-1151	S B K	¥ 1,400 ¥ 1,400 ¥ 1,400	
87	(フラットバー14巾) ⊗ 	① 4,000 ② 2.0 ③ N0-544	S B W K	¥ 1,300 ¥ 1,400 ¥ 1,500 ¥ 1,500	
88	(フラットバー15巾) ⊗ 	① 4,000 ② 2.0 ③ N0-1159	S B K SC AB	¥ 1,300 ¥ 1,400 ¥ 1,500 ¥ 1,600 ¥ 1,600	
89	(フラットバー20巾) ⊗ 	① 4,000 ② 2.0 ③ N0-1167	S B K SC AB	¥ 1,700 ¥ 1,800 ¥ 1,900 ¥ 2,100 ¥ 2,100	
90	(フラットバー20巾) ⊗ 	① 4,000 ② 2.5 ③ N0-545	S B W K SC	¥ 2,000 ¥ 2,100 ¥ 2,300 ¥ 2,400 ¥ 2,600	
91	(フラットバー25巾) ⊗ 	① 4,000 ② 2.0 ③ N0-1176	S B K SC AB	¥ 2,100 ¥ 2,200 ¥ 2,300 ¥ 2,500 ¥ 2,500	

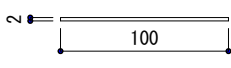
No.	製品型図	①長さ ②厚さ ③型番	色	定価	用途
92	(フラットバー30巾) ⊗ 	① 4,000 ② 2.0 ③ N0-1186	SC AB	¥ 3,000 ¥ 3,000	
93	(フラットバー30巾) ⊗ 	① 4,000 ② 2.2 ③ N0-546	S B W K SC	¥ 2,300 ¥ 2,500 ¥ 2,700 ¥ 2,700 ¥ 2,800	
94	(フラットバー35巾) ⊗ 	① 4,000 ② 2.0 ③ N0-1199	S B K SC AB	¥ 2,900 ¥ 3,000 ¥ 3,300 ¥ 3,600 ¥ 3,600	
95	(フラットバー35巾) ⊗ 	① 4,000 ② 3.0 ③ N0-547	S B W K	¥ 3,900 ¥ 4,100 ¥ 4,400 ¥ 4,600	
96	(フラットバー38巾) ⊗ 	① 4,000 ② 2.5 ③ N0-548	S B W K	¥ 3,500 ¥ 3,600 ¥ 4,000 ¥ 4,100	
97	(フラットバー40巾) ⊗ 	① 4,000 ② 3.0 ③ N0-1206	S B K SC AB	¥ 4,900 ¥ 5,100 ¥ 5,600 ¥ 6,100 ¥ 6,100	
98	(フラットバー43.2巾) ⊗ 	① 4,000 ② 3.0 ③ N0-549	S B W K SC AB	¥ 4,600 ¥ 4,800 ¥ 5,200 ¥ 5,400 ¥ 5,900 ¥ 5,900	

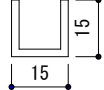
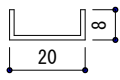
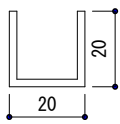
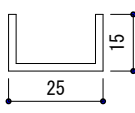
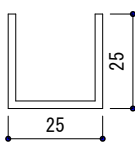

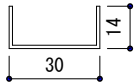
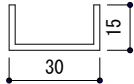
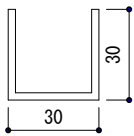
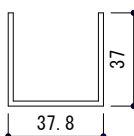
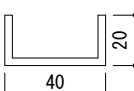
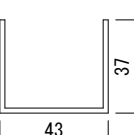
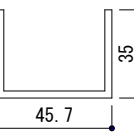

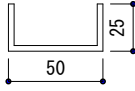
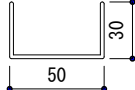
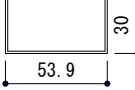
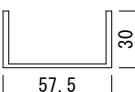
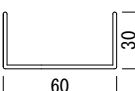
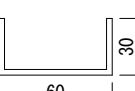
No.	製品型図	①長さ ②厚さ ③型番	色	定価	用途
99	(フラットバー50巾) 	① 4,000 ② 3.0 ③ N0-550	S B W K SC AB	¥ 5,000 ¥ 5,300 ¥ 5,900 ¥ 5,900 ¥ 6,600 ¥ 6,600	
100	(フラットバー50巾) ⊗ 	① 4,000 ② 5.0 ③ N0-1220	S B K	¥ 10,300 ¥ 10,800 ¥ 11,400	
101	(フラットバー60巾) ⊙ 	① 4,000 ② 3.0 ③ N0-551	S B W K	¥ 6,100 ¥ 6,400 ¥ 6,900 ¥ 7,100	
102	(フラットバー65巾) ⊙ 	① 4,000 ② 1.7 ③ N0-552	B K	¥ 5,500 ¥ 6,100	
103	(フラットバー70巾) ⊙ 	① 4,000 ② 3.0 ③ N0-553	S B W K	¥ 7,000 ¥ 7,500 ¥ 8,100 ¥ 8,400	
104	(フラットバー85巾) ⊙ 	① 4,000 ② 1.8 ③ N0-554	S B K	¥ 6,700 ¥ 7,500 ¥ 8,100	
105	(フラットバー85巾) 	① 4,000 ② 3.0 ③ N0-555	S B W K SC AB	¥ 9,300 ¥ 10,200 ¥ 10,500 ¥ 10,900 ¥ 11,300 ¥ 12,000	



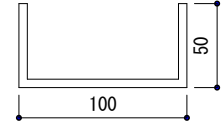
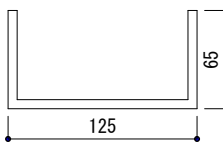
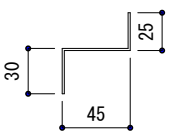
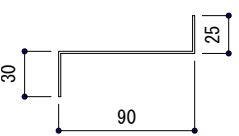
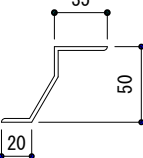
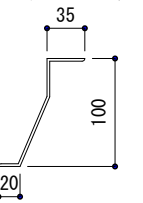
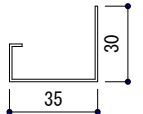

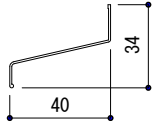
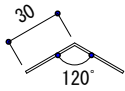
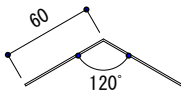
No.	製品型図	①長さ ②厚さ ③型番	色	定価	用途
106	(フラットバー100巾) ① 	① 4,000 ② 2.0 ③ N0-556	S B W K SC	¥ 8,100 ¥ 8,700 ¥ 9,500 ¥ 9,700 ¥ 10,500	
107	(10×10チャンネル) ② 	① 5,000 ② 1.6 ③ N0-1291	S B K	¥ 2,300 ¥ 2,400 ¥ 2,500	
108	(15×15チャンネル) ② 	① 5,000 ② 2.0 ③ N0-1292	S B K	¥ 4,300 ¥ 4,600 ¥ 4,800	
109	(20×8チャンネル) ② 	① 4,000 ② 1.2 ③ N0-576	S B W	¥ 1,500 ¥ 1,600 ¥ 1,800	W色のみ L=5970 在庫限り
110	(20×20チャンネル) ② 	① 5,000 ② 2.0 ③ N0-1293	S B K	¥ 5,900 ¥ 6,200 ¥ 6,600	
111	(25×15チャンネル) ② 	① 5,000 ② 2.0 ③ N0-1294	S B K	¥ 5,400 ¥ 5,600 ¥ 5,900	
112	(25×25チャンネル) ② 	① 5,000 ② 2.0 ③ N0-1295	S B K	¥ 7,300 ¥ 7,700 ¥ 8,100	

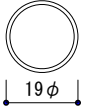
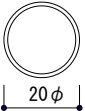
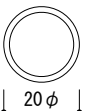

No.	製品型図	①長さ ②厚さ ③型番	色	定価	用途
113	(30×14チャンネル) ⊗ 	① 4,000 ② 1.1 ③ N0-577	S B W K	¥ 2,400 ¥ 2,500 ¥ 2,500 ¥ 2,600	
114	(30×15チャンネル) ⊗ 	① 5,000 ② 2.0 ③ N0-1296	S B K	¥ 5,900 ¥ 6,200 ¥ 6,600	
115	(30×30チャンネル) ⊗ 	① 5,000 ② 2.4 ③ N0-1297	S B K	¥ 10,600 ¥ 11,100 ¥ 11,800	
116	(37.8×37チャンネル) 	① 5,500 ② 2.0 ③ N0-590	S	¥ 12,100	
117	(40×20チャンネル) ⊗ 	① 5,000 ② 3.0 ③ N0-1299	S B K	¥ 11,600 ¥ 12,100 ¥ 12,800	
118	(43×37チャンネル) ⊗ 	① 5,500 ② 2.0 ③ N0-589	S	¥ 12,000	
119	(45.7×35チャンネル) 	① 5,500 ② 2.8 ③ N0-591	S	¥ 16,100	50角連結用

No.	製品型図	①長さ ②厚さ ③型番	色	定価	用途
120	(50×25チャンネル) ⊗ 	① 5,000 ② 3.0 ③ N0-1300	S B K	¥ 14,700 ¥ 15,400 ¥ 16,300	
121	(50×30チャンネル) 	① 5,500 ② 2.0 ③ N0-586	S B W K SC	¥ 10,900 ¥ 11,400 ¥ 13,200 ¥ 13,300 ¥ 14,100	ビル用面格子H材
122	(53.9×30チャンネル) ⊗ 	① 5,500 ② 1.2 ③ N0-585	S B W K	¥ 6,900 ¥ 7,200 ¥ 8,000 ¥ 8,500	
123	(57.5×30チャンネル) 	① 5,500 ② 3.0 ③ N0-588	S	¥ 20,000	パラストレー笠木角度連結材
124	(60×30チャンネル) ⊗ 	① 5,500 ② 2.0 ③ N0-587	S B	¥ 11,600 ¥ 12,200	ビル用面格子H材
125	(60×30チャンネル) ⊗ 	① 5,000 ② 3.0 ③ N0-1301	S B K	¥ 17,900 ¥ 18,700 ¥ 19,700	
126	(80×40チャンネル) ⊗ 	① 5,000 ② 4.0 ③ N0-1302	S B K	¥ 28,500 ¥ 29,700 ¥ 31,600	

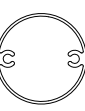
No.	製品型図	①長さ ②厚さ ③型番	色	定価	用途
127	(100×50チャンネル) ⊗ 	① 5,000 ② 5.0 ③ N0-1303	S B K	¥ 42,300 ¥ 44,400 ¥ 47,000	
128	(125×65チャンネル) ⊗ 	① 5,000 ② 6.0 ③ N0-1304	S B K	¥ 65,000 ¥ 68,200 ¥ 72,200	
129	(Zアングル45用) ⊗ 	① 5,500 ② 1.4 ③ N0-487	S B	¥ 7,000 ¥ 7,300	
130	(Zアングル90用) ⊗ 	① 5,500 ② 1.4 ③ N0-488	S B	¥ 9,600 ¥ 10,100	
131	(Zアングル50用) 	① 5,500 ② 2.5 ③ N0-489	S B W K	¥ 13,100 ¥ 14,000 ¥ 15,200 ¥ 16,100	
132	(Zアングル100用) 	① 5,500 ② 2.5 ③ N0-490	S B W K	¥ 19,600 ¥ 20,800 ¥ 22,600 ¥ 23,500	
133	(水切) ⊗ 	① 5,500 ② 1.0 ③ N0-493	S B K	¥ 5,100 ¥ 5,400 ¥ 6,000	

No.	製品型図	①長さ ②厚さ ③型番	色	定価	用途
134	(住宅用水切) ⊗ 	① 4,050 ② 0.9 ③ N0-492	S B K	¥ 2,400 ¥ 2,600 ¥ 2,900	
135	(120度アングル30) ⊗ 	① 5,500 ② 1.2 ③ N0-476	S	¥ 4,300	
136	(120度アングル60) ⊗ 	① 6,000 ② 1.2 ③ N0-494	B K	¥ 8,400 ¥ 9,100	
137	(10φ) ⊗ 	① 5,000 ② 1.0 ③ N0-1311	S B K	¥ 1,500 ¥ 1,500 ¥ 1,600	
138	(12φ) ⊗ 	① 5,000 ② 1.0 ③ N0-1312	S B K	¥ 1,900 ¥ 1,900 ¥ 2,000	
139	(15φ) ⊗ 	① 5,000 ② 1.0 ③ N0-1313	S B K	¥ 2,300 ¥ 2,400 ¥ 2,600	
140	(16φ) ⊗ 	① 5,000 ② 1.0 ③ N0-1314	S B K	¥ 2,500 ¥ 2,600 ¥ 2,700	

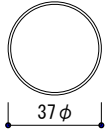
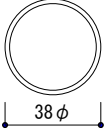
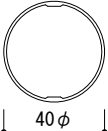
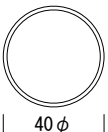
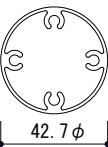
No.	製品型図	①長さ ②厚さ ③型番	色	定価	用途
141	(19φ) 	① 5,000 ② 1.0 ③ N0-1315	S B K	¥ 2,900 ¥ 3,000 ¥ 3,300	
142	(20φ) 	① 5,000 ② 1.0 ③ N0-1316	S B K	¥ 3,400 ¥ 3,500 ¥ 3,700	
143	(20φ) 	① 5,000 ② 1.5 ③ N0-1317	S B K	¥ 4,600 ¥ 4,800 ¥ 5,100	
144	(20φ) 	① 5,000 ② 2.0 ③ N0-1318	S B K	¥ 5,900 ¥ 6,100 ¥ 6,500	
145	(24φ) 	① 5,700 ② 0.8 ③ N0-560	S B W K SC	¥ 4,400 ¥ 4,700 ¥ 5,100 ¥ 5,200 ¥ 5,500	キャップ有
146	(30φ) 	① 6,000 ② 1.1 ③ N0-567	B K	¥ 7,400 ¥ 7,600	キャップ有
147	(34.5φ) 	① 6,000 ② ③ N0-564	S B W K	¥ 10,100 ¥ 10,600 ¥ 11,700 ¥ 12,000	

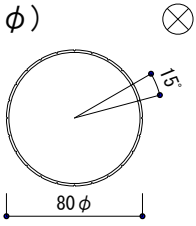
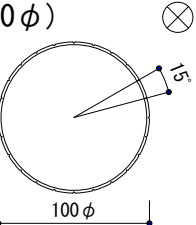
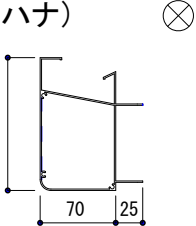
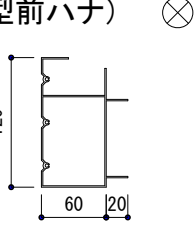
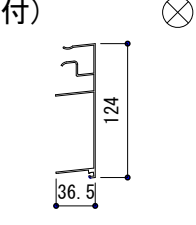
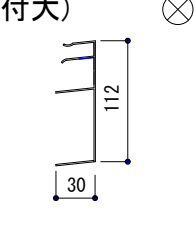
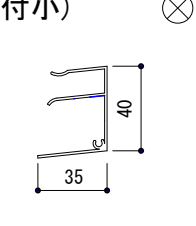

No.	製品型図	①長さ ②厚さ ③型番	色	定価	用途
148	(37φ) 	① 5,500 ② 1.0 ③ N0-561	S B W K	¥ 5,600 ¥ 5,900 ¥ 6,400 ¥ 6,600	
149	(38φ) 	① 5,630 ② 1.8 ③ N0-562	S	¥ 10,600	
150	(40φ) 	① 6,000 ② 1.1 ③ N0-568	B K	¥ 9,700 ¥ 10,200	キャップ有
151	(40φ) 	① 6,000 ② 1.5 ③ N0-563	S B K SC	¥ 10,200 ¥ 10,600 ¥ 12,200 ¥ 13,700	キャップ有
152	(42.7φ) 	① 6,000 ② ③ N0-565	S B W K	¥ 12,000 ¥ 12,600 ¥ 13,700 ¥ 14,100	
153	(50φ) 	① 6,000 ② 1.1 ③ N0-569	B K	¥ 11,100 ¥ 12,100	キャップ有
154	(60φ) 	① 6,000 ② 1.1 ③ N0-570	B K	¥ 13,800 ¥ 14,200	キャップ有

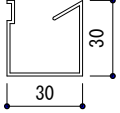
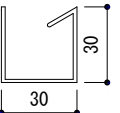
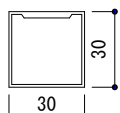
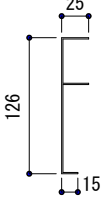
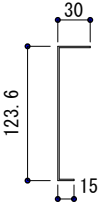
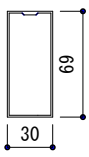
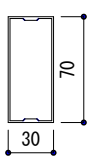

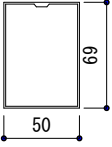
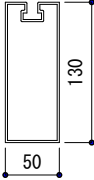
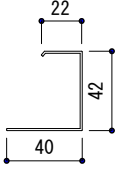
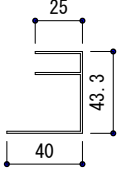
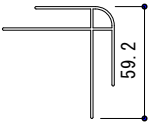
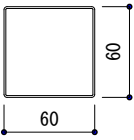
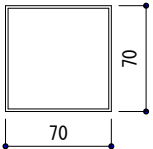

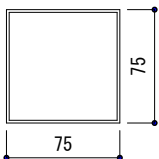
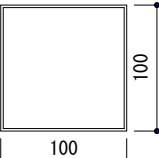
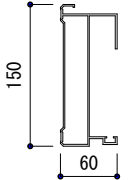
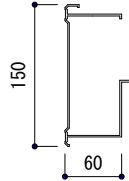
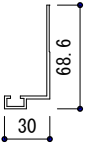
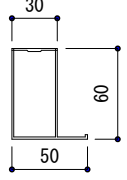
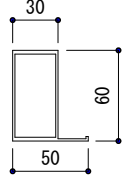
No.	製品型図	①長さ ②厚さ ③型番	色	定価	用途
155	(80φ) 	① 6,000 ② 1.8 ③ N0-571	B K	¥ 29,400 ¥ 32,600	全面ライン有 キャップ有
156	(100φ) 	① 6,000 ② 1.8 ③ N0-572	B K	¥ 37,100 ¥ 41,000	全面ライン有 キャップ有
157	(前ハナ) 	① 6,000 ② 1.5 ③ KA-262	B	¥ 28,400	波板テラス 在庫限り
158	(C型前ハナ) 	① 5,770 ② ③ N0-229	S B W K SC	¥ 30,500 ¥ 32,000 ¥ 33,600 ¥ 36,200 ¥ 37,100	波板テラス
159	(打付) 	① 6,000 ② 1.3 ③ U-0699	B SC	¥ 17,000 ¥ 18,000	波板テラス 在庫限り
160	(打付大) 	① 5,770 ② 1.1 ③ N0-242	B K SC	¥ 15,400 ¥ 17,400 ¥ 17,800	波板テラス
161	(打付小) 	① 5,770 ② 1.5 ③ N0-241	S B W K SC	¥ 10,400 ¥ 10,900 ¥ 11,900 ¥ 12,300 ¥ 12,600	波板テラス

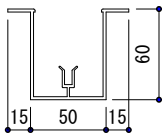
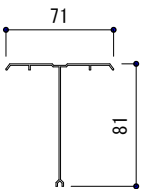
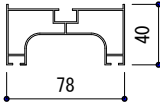
No.	製品型図	①長さ ②厚さ ③型番	色	定価	用途
162	(モヤ) ⊗ 	① 6,000 ② 1.1 ③ KA-263	B SC	¥ 6,000 ¥ 6,600	波板テラス
163	(モヤ) ⊗ 	① 5,770 ② 1.5 ③ N0-239 N0-238	S B W K AB	¥ 7,400 ¥ 7,800 ¥ 8,600 ¥ 8,900 ¥ 6,700	波板テラス AB色のみ t1.0
164	(30角モヤ) ⊗ 	① 5,770 ② 1.1 ③ N0-240	S B W K	¥ 8,300 ¥ 8,600 ¥ 9,400 ¥ 9,700	波板テラス キャップ有
165	(サイド板) ⊗ 	① 6,000 ② 1.2 ③ KA-261	B	¥ 12,800	波板テラス 在庫限り
166	(C型サイド板) ⊗ 	① 5,520 ② ③ N0-230	S B W K SC	¥ 11,400 ¥ 12,000 ¥ 12,600 ¥ 13,600 ¥ 13,900	波板テラス
167	(タルキ) ⊗ 	① 5,350 ② 1.1 ③ N0-234	S B W K SC AB	¥ 10,300 ¥ 10,800 ¥ 11,700 ¥ 12,100 ¥ 12,300 ¥ 13,500	波板テラス キャップ有
168	(タルキ) ⊗ 	① 5,800 ② 1.3 ③ KN-024	B SC	¥ 13,500 ¥ 14,300	波板テラス 在庫限り キャップ有

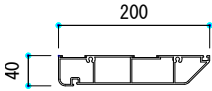
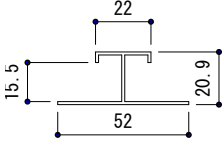
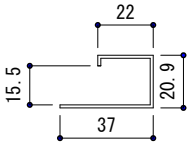
No.	製品型図	①長さ ②厚さ ③型番	色	定価	用途
169	(50×69角) ⊗ 	① 5,350 ② 1.2 ③ N0-236	B W K SC AB	¥ 14,400 ¥ 15,800 ¥ 16,300 ¥ 16,600 ¥ 17,700	大型テラスタルキ キャップ有
170	(50×130ケタ) ⊗ 	① 5,500 ② 2.0 ③ N0-250	S B W K	¥ 31,400 ¥ 32,900 ¥ 36,000 ¥ 37,200	大型テラス補強型材 キャップ有
171	(波板止片) 	① 5,500 ② 1.1 ③ J-9670	B SC	¥ 5,300 ¥ 6,000	波板テラス前・側面波板止用 在庫限り
172	(波板止片) ⊙ 	① 5,500 ② ③ N0-254	B K SC	¥ 7,100 ¥ 8,000 ¥ 8,200	波板テラス前・側面波板止用
173	(波板止両) ⊙ 	① 5,500 ② 1.2 ③ N0-253	B K	¥ 10,600 ¥ 11,900	波板テラスコーナー部波板止
174	(60角) ⊙ 	① 5,800 ② 1.5 ③ N0-261 U-5564	S B W K SC	¥ 16,000 ¥ 14,900 ¥ 19,000 ¥ 20,100 ¥ 15,800	テラス柱 プレス加工可 S・W・Kのみ6m キャップ有
175	(70角) ⊙ 	① 5,800 ② 1.7 ③ U-6434	S B SC	¥ 20,400 ¥ 22,100 ¥ 23,400	テラス柱 プレス加工不可 キャップ有

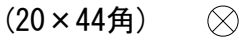
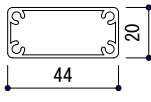
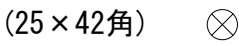
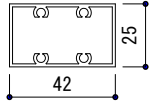
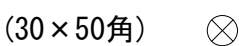
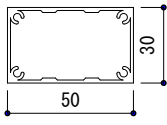
No.	製品型図	①長さ ②厚さ ③型番	色	定価	用途
176	(75角) 	① 6,000 ② 1.8 ③ N0-536 J-8119	S B W K SC	¥ 23,200 ¥ 25,100 ¥ 27,500 ¥ 28,500 ¥ 26,600	大型テラス柱 プレス加工不可 キャップ有
177	(100角) 	① 6,000 ② 1.8 ③ N0-537	S B W K	¥ 33,600 ¥ 35,600 ¥ 39,200 ¥ 41,200	大型テラス柱 キャップ有
178	(バルコニー前枠) 	① 6,000 ② ③ N0-289	B K	¥ 42,000 ¥ 48,300	
179	(バルコニー側枠) 	① 5,500 ② ③ N0-290	B K	¥ 29,400 ¥ 33,600	
180	(バルコニーネダカケ) 	① 6,000 ② ③ N0-292	B K	¥ 12,600 ¥ 14,700	
181	(バルコニーネダA) 	① 5,500 ② 1.2 ③ N0-294	B K	¥ 13,100 ¥ 14,100	ネタピッチ≒450
182	(バルコニーネダB) 	① 5,500 ② 1.5 2.5 ③ N0-295	B K	¥ 18,900 ¥ 21,000	ネタピッチ≒450

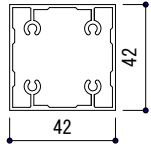
No.	製品型図	①長さ ②厚さ ③型番	色	定価	用途
183	(連結ネダA) ⊗ 	① 5,500 ② ③ N0-297	B	¥ 25,200	
			K	¥ 27,300	
184	(連結ネダカバー) ⊗ 	① 5,500 ② ③ N0-299	B	¥ 10,500	
			K	¥ 12,600	
185	(束受け) ⊗ 	① 6,000 ② ③ N0-303	B	¥ 21,300	
			K	¥ 24,200	
186	(階段側面板) ⊗ 	① 6,000 ② 2.5 ③ N0-309	S	¥ 48,100	
187	(階段フミ板) ⊗ 	① 5,500 ② 2.0 ③ N0-310	S	¥ 57,300	
188	(スパンジョイント) ⊗ 	① 4,000 ② 1.2 ③ N0-437	S	¥ 4,100	
			B	¥ 4,600	
			W	¥ 5,000	
			K	¥ 5,300	
			SC	¥ 5,300	
189	(スパンエンド) ⊗ 	① 4,000 ② 1.2 ③ N0-438	S	¥ 3,400	
			B	¥ 3,800	
			W	¥ 4,100	
			K	¥ 4,200	
			SC	¥ 4,200	

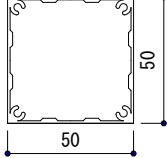
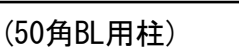
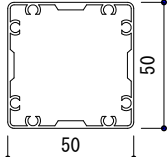
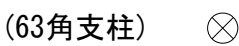
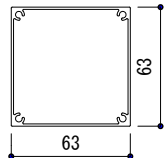

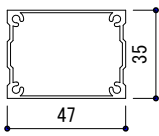
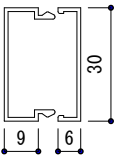
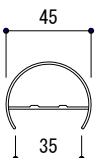
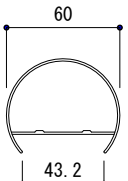
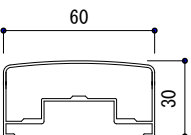
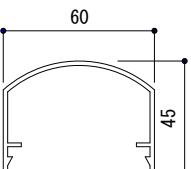
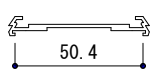
No.	製品型図	①長さ ②厚さ ③型番	色	定価	用途
190	(20×44角)  	① 6,000 ② 1.2 ③ N0-515	S B W K	¥ 10,400 ¥ 10,900 ¥ 12,000 ¥ 13,000	
191	(25×42角)  	① 6,000 ② 1.2 ③ N0-29	S B W K	¥ 11,800 ¥ 12,400 ¥ 13,400 ¥ 14,000	
192	(30×50角)  	① 6,000 ② 1.2 ③ N0-522	S B W K SC	¥ 14,900 ¥ 15,700 ¥ 17,000 ¥ 17,500 ¥ 18,000	キャップ有
193	(42角)  	① 6,000 ② 1.2 ③ N0-523	S B W K SC AB	¥ 17,000 ¥ 18,000 ¥ 19,500 ¥ 20,200 ¥ 21,000 ¥ 22,000	アルミキャップ有
194	(50角)  	① 6,000 ② 1.2 ③ N0-524	S B W K SC AB	¥ 17,000 ¥ 17,900 ¥ 19,500 ¥ 20,200 ¥ 20,600 ¥ 21,800	
195	(50角BL用柱)  	① 3,900 ② ③ T-387	S DB K SC	¥ 20,300 ¥ 24,600 ¥ 24,600 ¥ 24,600	BL手摺柱 (艶消し) キャップ有
196	(63角支柱)  	① 6,000 ② 1.2 ③ N0-532	S B W K SC AB	¥ 20,000 ¥ 21,000 ¥ 23,100 ¥ 23,600 ¥ 24,200 ¥ 25,600	キャップ有

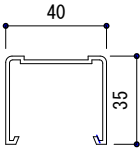
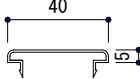
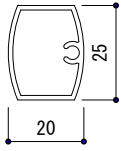
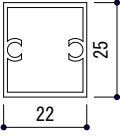
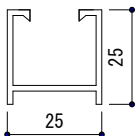
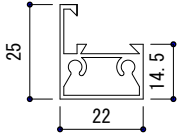
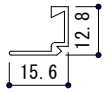
No.	製品型図	①長さ ②厚さ ③型番	色	定価	用途
197	(50角用スライド柱) 	① 5,500 ② 1.4 ③ N0-521	S	¥ 11,500	NO524 50角連結
198	(15×30角) ⊗ 	① 6,000 ② 1.2 ③ N0-510	B K	¥ 8,000 ¥ 8,000	キャップ有
199	(45φ半丸笠木) ⊗ 	① 6,000 ② ③ N0-26	S B W K	¥ 9,200 ¥ 9,800 ¥ 10,600 ¥ 11,200	
200	(60φ半丸笠木) ⊗ 	① 6,000 ② ③ N0-25	S B W K SC AB	¥ 12,600 ¥ 13,200 ¥ 14,400 ¥ 14,800 ¥ 15,300 ¥ 16,400	
201	(30×60笠木) ⊗ 	① 6,000 ② ③ N0-17	S B W K SC	¥ 11,200 ¥ 11,800 ¥ 12,800 ¥ 13,200 ¥ 13,500	
202	(P型笠木) 	① 3,900 ② ③ T-2	S DB K SC	¥ 9,800 ¥ 11,800 ¥ 11,800 ¥ 11,800	パラストレー手摺 全て艶消し
203	(P型上レール) 	① 3,900 ② ③ T-1	S DB K SC	¥ 5,100 ¥ 6,200 ¥ 6,200 ¥ 6,200	パラストレー手摺 全て艶消し

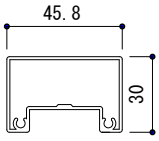
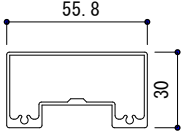
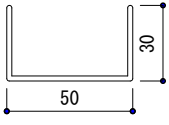
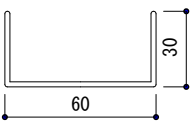
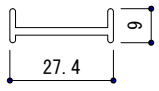
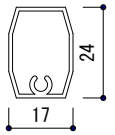
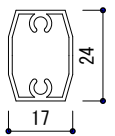
No.	製品型図	①長さ ②厚さ ③型番	色	定価	用途
204	(P型下レール) 	① 3,900 ② 1.2 ③ T-3	S DB K SC	¥ 6,700 ¥ 8,100 ¥ 8,100 ¥ 8,100	パラストレ－手摺 全て艶消し
205	(下レールカバー) 	① 3,900 ② 1.1 ③ T-391	S DB K SC	¥ 3,700 ¥ 4,500 ¥ 4,500 ¥ 4,500	パラストレ－手摺 全て艶消し
206	(P型立子) 	① 3,900 ② 1.2 ③ T-10	S DB K SC	¥ 4,400 ¥ 5,400 ¥ 5,400 ¥ 5,400	パラストレ－手摺 全て艶消し
207	(BL立子) 	① 3,900 ② ③ T-388	S	¥ 7,100	B L手摺
208	(P型パネルW材) 	① 3,900 ② 1.2 ③ T-12	S DB K SC	¥ 4,800 ¥ 5,900 ¥ 5,900 ¥ 5,900	パラストレ－手摺 全て艶消し
209	(P型パネルH材) 	① 3,900 ② 1.2 ③ T-13	S DB W K	¥ 6,400 ¥ 7,700 ¥ 7,700 ¥ 7,700	パラストレ－手摺 全て艶消し
210	(P型パネル押縁材) 	① 3,900 ② 1.2 ③ T-14	S DB K SC	¥ 2,400 ¥ 2,900 ¥ 2,900 ¥ 2,900	パラストレ－手摺 全て艶消し

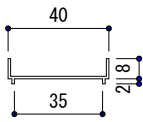
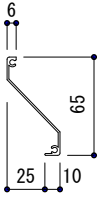
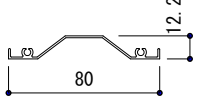
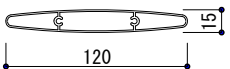
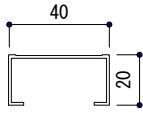
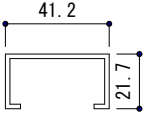
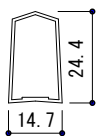
No.	製品型図	①長さ ②厚さ ③型番	色	定価	用途
211	(ビル用面格子W材) 	① 6,000 ② 1.2 ③ N0-117	S B W K SC	¥ 12,300 ¥ 13,000 ¥ 14,300 ¥ 15,000 ¥ 15,800	ビル用面格子・門扉
212	(ビル用面格子W材大) 	① 6,000 ② 1.3 ③ N0-119	S B	¥ 16,000 ¥ 16,700	ビル用面格子
213	(ビル用面格子H材) 	① 5,500 ② 2.0 ③ N0-116	S B W K SC	¥ 10,900 ¥ 11,500 ¥ 13,300 ¥ 13,300 ¥ 14,100	ビル用面格子
214	(ビル用面格子H材大) 	① 5,500 ② 2.0 ③ N0-118	S B	¥ 11,600 ¥ 12,200	ビル用面格子
215	(パネルバー) 	① 6,000 ② ③ N0-3	S B W K SC AB	¥ 3,700 ¥ 3,800 ¥ 4,200 ¥ 4,400 ¥ 4,400 ¥ 4,300	ビル用面格子・門扉
216	(立子) 	① 5,700 ② ③ N0-5	S B W K SC AB	¥ 3,700 ¥ 3,800 ¥ 4,200 ¥ 4,400 ¥ 4,400 ¥ 4,400	ビル用面格子・門扉
217	(立子2本ビス) ⊗ 	① 5,700 ② ③ N0-6	S B W K	¥ 4,300 ¥ 4,500 ¥ 4,900 ¥ 5,200	ビル用面格子・門扉

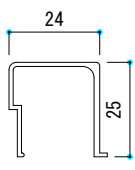
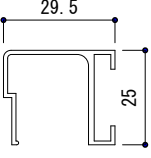

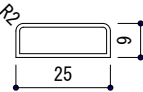
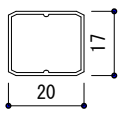
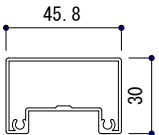
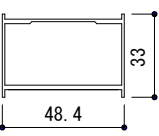

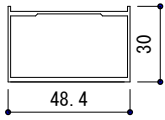
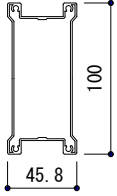
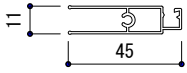
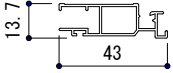
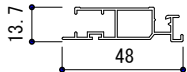
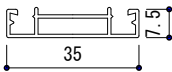
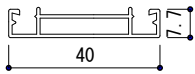
No.	製品型図	①長さ ②厚さ ③型番	色	定価	用途
218	(羽根受) ⊗ 	① 5,000 ② 1.0 ③ N0-115	S B W K SC	¥ 2,900 ¥ 3,000 ¥ 3,300 ¥ 3,600 ¥ 3,700	水切羽根受材
219	(水切型羽根) ⊗ 	① 6,000 ② 1.2 ③ N0-114	S B W K SC	¥ 7,400 ¥ 7,800 ¥ 8,400 ¥ 9,000 ¥ 9,400	
220	(ガラリ立羽根) ⊗ 	① 5,700 ② ③ N0-52	S B W K	¥ 7,200 ¥ 7,600 ¥ 8,300 ¥ 8,500	
221	(R付立羽根) ⊗ 	① 6,000 ② 1.1 ③ N0-335	B K	¥ 22,400 ¥ 24,500	
222	(面格子W材) 	① 5,500 ② 1.1 ③ N0-106	S B W K SC AB	¥ 5,000 ¥ 5,600 ¥ 6,500 ¥ 6,500 ¥ 7,000 ¥ 7,000	住宅用面格子 キャップ有 AB色のみ L 5700
223	(面格子W材) ⊗ 	① 5,700 ② 1.8 ③ N0-107	S B K	¥ 7,600 ¥ 8,500 ¥ 9,500	住宅用面格子
224	(面格子H材) 	① 5,500 ② 1.1 ③ N0-105	S B W K SC AB	¥ 2,200 ¥ 2,700 ¥ 2,900 ¥ 3,200 ¥ 3,400 ¥ 3,600	住宅用面格子 キャップ有

No.	製品型図	①長さ ②厚さ ③型番	色	定価	用途
225	(クロス枠) 	① 5,500 ② ③ N0-110	S B W K SC AB	¥ 4,300 ¥ 4,600 ¥ 5,000 ¥ 5,400 ¥ 5,600 ¥ 6,000	クロス格子・マスコ格子
226	(クロススライド枠) 	① 5,500 ② ③ N0-111	S B W K SC	¥ 4,900 ¥ 5,300 ¥ 5,800 ¥ 5,900 ¥ 6,000	クロス格子・マスコ格子
227	(クロス組子) 	① 4,000 ② 1.1 ③ N0-108	S B W K SC AB	¥ 1,300 ¥ 1,400 ¥ 1,500 ¥ 1,600 ¥ 1,900 ¥ 1,900	クロス格子・マスコ格子
228	(クロス組子大)⊗ 	① 5,500 ② 1.0 ③ N0-126	S B W K SC AB	¥ 3,600 ¥ 4,000 ¥ 4,300 ¥ 4,400 ¥ 4,800 ¥ 4,900	クロス格子・マスコ格子
229	(17×20角格子)⊗ 	① 5,500 ② 1.0 ③ N0-109	S B W K SC	¥ 3,000 ¥ 3,100 ¥ 3,300 ¥ 3,600 ¥ 3,900	四方枠立格子
230	(門扉W材) 	① 6,000 ② 1.2 ③ N0-131	S B W K	¥ 12,300 ¥ 13,000 ¥ 14,300 ¥ 15,000	ビル用面格子・門扉
231	(門扉H材B) 	① 5,500 ② ③ N0-130	S B W K	¥ 11,000 ¥ 11,600 ¥ 12,600 ¥ 13,100	門扉

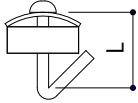
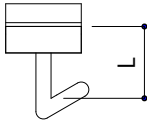
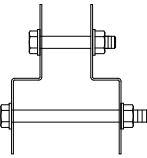
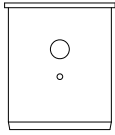
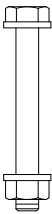
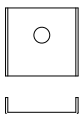
No.	製品型図	①長さ ②厚さ ③型番	色	定価	用途
232	(門扉H材A) 	① 5,500 ② ③ N0-129	S B W K	¥ 10,500 ¥ 11,200 ¥ 12,200 ¥ 12,500	門扉
233	(門扉中棧材) 	① 5,500 ② 1.2 ③ N0-132	S B W K	¥ 22,700 ¥ 23,800 ¥ 26,000 ¥ 26,800	門扉
234	(網戸W材) 	① 5,600 ② 1.2 ③ UF-136	S B W K SC	¥ 4,900 ¥ 5,400 ¥ 6,000 ¥ 6,000 ¥ 6,000	網戸
235	(網戸H材) 	① 5,600 ② 1.2 ③ UF-135	S B W K SC	¥ 4,700 ¥ 5,200 ¥ 5,800 ¥ 5,800 ¥ 5,800	網戸
236	(網戸召合材) 	① 5,500 ② 1.2 ③ UF-134	S B W K SC	¥ 5,000 ¥ 5,600 ¥ 6,300 ¥ 6,300 ¥ 6,300	網戸
237	(網戸中棧) 	① 4,000 ② 1.2 ③ UF-138	S B SC	¥ 2,600 ¥ 2,600 ¥ 2,900	網戸
238	(網戸中棧) 	① 4,000 ② 1.2 ③ N0-148	S B W K SC	¥ 2,600 ¥ 2,600 ¥ 2,900 ¥ 2,900 ¥ 3,200	網戸

No.	製品型図	①長さ ②厚さ ③型番	色	定価	用途

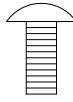
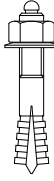
No.	製品名	定 価		用 途
		数	量	
1	(ステンフック) 	20 L	¥ 50	波板止用
	22 L	¥ 60		
	1ヶ			
2	(ポリカフック) 	19 L	¥ 35	波板止用
	21 L	¥ 40		
	1ヶ			
3	(ステン柱プレート) 	¥ 1,500		テラス70角柱用 プレート×2 M8×50ボルト×1 M8×90ボルト×1
	1セット			
4	(柱ライナー) 	¥ 2,000		テラス柱用 ライナー樹脂×2 (60用・75用) M8ボルト×1
	1セット			
5	(柱ボルト) 	M8×50	¥ 210	ステン
	M8×70	¥ 260		
	M8×90	¥ 290		
	1本			
6	(タルキプレート) 	¥ 460		30・50用有 テラス打ち付け小 ステン
	1ヶ			

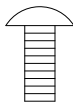
No.	製品名	定 価		用 途
		数	量	
7	(タルキボルト) 	M6×90	¥ 230	ステン
	1本			
8	(コーチボルト) 	M6×70	¥ 230	ステン
	1本			
9	(モヤ押えビス) 	M5×12	¥ 35	ステン
	1本			
10	(アンカー) 	M8×50	¥ 460	ステン
	M8×70	¥ 700		
1本				
11	(プラグ) 	S 5	¥ 50	樹脂
	S 6	¥ 60		
	S 8	¥ 80		
	1本			
12	(トラスビス) 	M4×10	¥ 20	ステン (S・B色)
	1本			

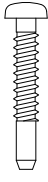
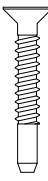
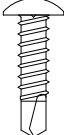
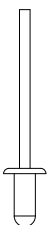
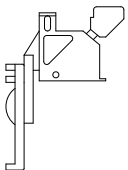
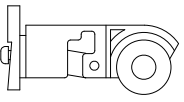
No.	製品名	定 価		用 途
		数	量	
13	(組立ビス) 	M4×25	¥ 15	ステン
		1本		
14	(サラ組立ビス) 	M4×20	¥ 15	ステン
		1本		
15	(ピアスビス) 	4×16	¥ 35	ステン
		4×25	¥ 50	
5×19	¥ 60			
		1本		
16	(リベット) 	4-3	¥ 20	面格子用 クロス用 クロス用
		5-3	¥ 20	
5-7	¥ 25			
		1本		S・B・W・K・SC色
17	(網戸フレ止め) 	¥ 150		中芯・偏芯用 TU-02 TU-01
		1ヶ		
18	(網戸戸車) 	¥ 200		中芯・偏芯用 TU-20 TU-10
		1ヶ		



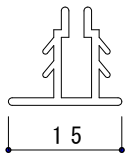
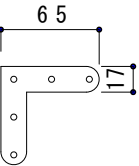
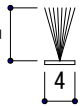

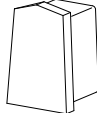
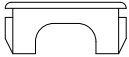
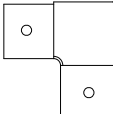
No.	製品名	定 価		用 途
		数	量	
19	(ビル用フレ止め) 	¥ 350		裏板付ステン TS-BF1
		1ヶ		
20	(ビル用戸車) 	¥ 520		裏板付ステン TS-BT1
		1ヶ		
21	(旧ビル用フレ止) 	¥ 300		ステン
		1ヶ		
22	(旧ビル用戸車) 	¥ 350		ステン
		1ヶ		
23	(旧フレ止め) 	¥ 180		ブロンズ
		1ヶ		
24	(旧戸車) 	¥ 180		直径20mm 厚み6.5mm ミゾ 4mm
		1ヶ		

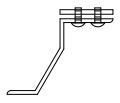
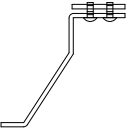
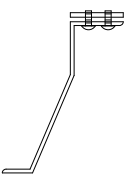
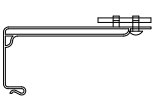
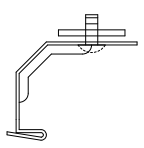
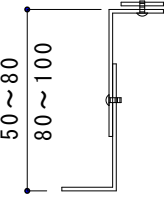
No.	製品名	定 価		用 途
		数	量	
25	(ビル用スキマフサギ) 	¥ 580		L=1900 樹 脂
	1本			
26	(L型金具) 	¥ 350		固定網戸用 ステン
	1ヶ			
27	(モヘア) ベース巾=4mm 	4090 ¥ 140	L= 7mm 中心用 L= 4mm 偏芯用 L=10mm L=13mm	
	4060 ¥ 140			
40120-1P ¥ 160				
40150-2P ¥ 160				
1M				
28	(押えゴム)	3.0φ ¥ 50		
	3.4φ ¥ 50			
4.2φ ¥ 50				
4.8φ ¥ 70				
1M				
29	(押えゴム)	5.2φ ¥ 70		
	6.0φ ¥ 80			
6.5φ ¥ 100				
7.0φ ¥ 120				
1巻				
30	(グレーネット) 18メッシュ	910巾 ¥ 10,600	ポリプロピレン	
	970巾 ¥ 13,200			
1210巾 ¥ 18,100				
1430巾 ¥ 19,200				
1巻				

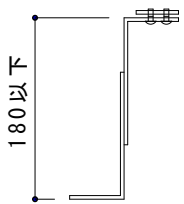
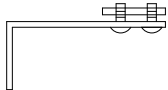
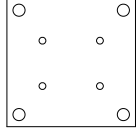
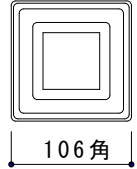
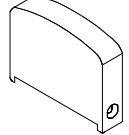
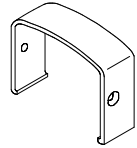

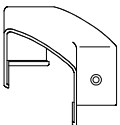
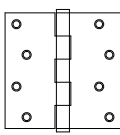
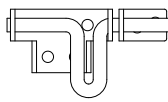
No.	製品名	定 価		用 途
		数	量	
31	(ブラックネット) 18メッシュ	910巾 ¥ 10,600	ポリプロピレン	
	970巾 ¥ 13,200			
1210巾 ¥ 18,100				
1430巾 ¥ 19,200				
1巻				
32	(ステンネット) 18メッシュ	910巾 ¥ 52,700		
	1000巾 ¥ 62,000			
1210巾 ¥ 84,000				
1510巾 ¥ 142,200				
1巻				
33	(レックスネット) 16×18メッシュ	910巾 ¥ 22,400	グラスファイバー (グレー色)	
	1210巾 ¥ 30,200			
1巻				
34	(面格子Hキャップ) 	¥ 20		B・W・K・SC色 樹 脂
	1ヶ			
35	(面格子Wキャップ) 	¥ 40	B・W・K・SC色 樹 脂	
	1ヶ			
36	(クロスコーナー) 	¥ 350	B・W・K・SC色 樹 脂	
	1ヶ			

No.	製品名	定 価	用 途
		数 量	
37	(壁付BL50用) 	¥ 1,750	面格子用 S・B・W・K・SC色 アルミ
		1セット(4ヶ)	
38	(壁付BL75用) 	¥ 1,850	面格子用 S・B・W・K・SC色 アルミ
		1セット(4ヶ)	
39	(壁付BL100用) 	¥ 2,400	面格子用 S・B・W・K色 アルミ
		1セット(4ヶ)	
40	(ワンタッチBL) 	¥ 2,000	面格子用 S・B・K色 30・60用有 ス テ ン
		1セット(4ヶ)	
41	(ワンタッチBL) 	¥ 2,100	クロス格子用 30用 ス テ ン
		1セット(4ヶ)	
42	(スライドBL) 	¥ 3,400	スライド枠式 クロス格子用 ス テ ン
		1セット(4ヶ)	

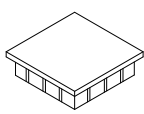
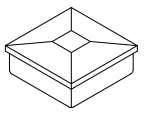
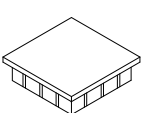
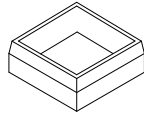
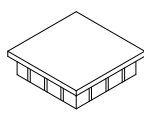

No.	製品名	定 価	用 途
		数 量	
43	(特注BL) 	¥ 1,100	S・B・W・K・SC色 アルミ
		1ヶ	
44	(戸袋BL) 	¥ 550	面格子用 アルミ
		1ヶ	
45	(アンカープレート) 	¥ 800	アルミ
		1枚	
46	(プレートカバー) 	¥ 800	50角柱用 S・B・K・SC色 樹脂
		1ヶ	
47	(エンドキャップ) 	¥ 500	P型笠木用 S・B・K・SC色 樹脂
		1ヶ	
48	(ジョイントカバー) 	¥ 600	P型笠木用 S・B・K・SC色 樹脂
		1ヶ	

No.	製品名	定 価	用 途
		数 量	
49	(コーナーカバー) 	¥ 700	P型笠木用 S・B・K・SC色 樹 脂
	1ヶ		
50	(丁番) 	¥ 1,300	ステン
	1ヶ		
51	(ラッチ錠) 	¥ 2,000	ステン
	1セット		
52	(引手) 	¥ 1,000	ステン
	1ヶ		
53	(門扉組立ビス) 	¥ 70	M4×60 ステン
	1本		
54	(穴フサギキャップ) 	¥ 45	10φ用 樹 脂
	1ヶ		

No.	製品名	定 価	用 途
		数 量	
55	(門扉Hキャップ) 	¥ 700	B・W・K色 樹 脂
	1ヶ		
56	(20角キャップ) 	¥ 350	B・W・K・SC色 樹 脂
	1ヶ		
57	(25角キャップ) 	¥ 350	B・W・K・SC色 樹 脂
	1ヶ		
58	(30角キャップ) 	¥ 350	S・B・K・SC色 樹 脂
	1ヶ		
59	(40角キャップ) 	¥ 450	S・B・K・SC色 樹 脂
	1ヶ		
60	(50角キャップ) 	¥ 450	S・B・K・SC色 樹 脂
	1ヶ		

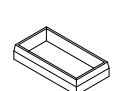
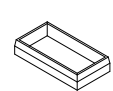
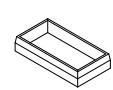
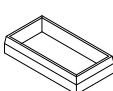
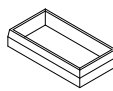
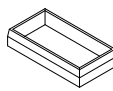
No.	製品名	定 価		用 途
		数	量	
61	(60角キャップ) 		¥ 800	S・AB・K・W・SC色 樹 脂
		1ヶ		
62	(65角キャップ) 		¥ 900	S・K・SC色 樹 脂
		1ヶ		
63	(70角キャップ) 		¥ 800	S・AB・W・K・SC色 樹 脂
		1ヶ		
64	(75角キャップ) 		¥ 900	S・AB・W・K・SC色 樹 脂
		1ヶ		
65	(100角キャップ) 		¥ 2,300	S・AB・W・K・SC色 樹 脂
		1ヶ		
66	(15×20角キャップ) 		¥ 350	S・B・K・SC色 樹 脂
		1ヶ		

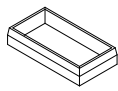
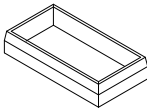
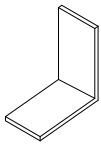
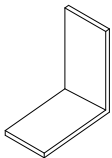
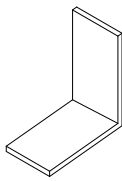
No.	製品名	定 価		用 途
		数	量	
67	(20×40角キャップ) 		¥ 350	S・B・K・SC色 樹 脂
		1ヶ		
68	(25×50角キャップ) 		¥ 350	S・B・K・SC色 樹 脂
		1ヶ		
69	(30×50角キャップ) 		¥ 500	S・B・K・SC色 樹 脂
		1ヶ		
70	(30×70角キャップ) 		¥ 500	S・B・K・SC色 樹 脂
		1ヶ		
71	(40×60角キャップ) 		¥ 500	S・B・K・SC色 樹 脂
		1ヶ		
72	(40×80角キャップ) 		¥ 700	S・B・K・SC色 樹 脂
		1ヶ		

No.	製品名	定 価	用 途
		数 量	
73	(50×70角キャップ) 	¥ 700	S・B・K・SC色 樹 脂
		1ヶ	
74	(50×100角キャップ) 	¥ 1,150	S・B・K・SC色 樹 脂
		1ヶ	
75	(30L、t=3) 	¥ 250	S・B・W・K・SC色 アルミ
		L=100	
76	(40L、t=3) 	¥ 350	S・B・W・K・SC色 アルミ
		L=100	
77	(50L、t=3) 	¥ 500	S・B・K・SC色 アルミ
		L=100	
78	(15×40L、t=3) 	¥ 250	S・B・W・K・SC色 アルミ
		L=100	

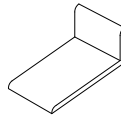
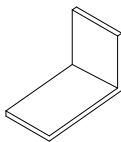
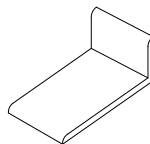
No.	製品名	定 価	用 途
		数 量	
79	(30×70L、t=2.5) 	¥ 500	S・B・W・K・SC色 アルミ
		L=100	
80	(40×60L、t=4) 	¥ 600	内側R付 S・B・W・K色 アルミ
		L=100	
81	(50×100L、t=5) 	¥ 1,050	S・B・W・K・SC色 アルミ
		L=100	
82	(アルミ複合板) 3×6尺	¥ 9,800	S・B・W・K・SC色 t= 3
		1枚	
83	(アルミ複合板) 1×2M	¥ 14,700	S・B・W・K・SC色 t= 3
		1枚	
84	(ケイカル板) 3×6尺	¥ 4,150	t= 6
		1枚	

網戸張り替え定価表
ステンレスネット18メッシュ

W寸 H寸	930マデ	931~1,300	1,031~1,350	1,351以上
400	2,000	2,200	2,600	2,800
500	2,200	2,400	2,800	3,000
600	2,400	2,700	3,100	3,300
700	2,700	3,000	3,500	3,800
800	2,900	3,300	3,800	4,100
900	3,100	3,500	4,100	4,400
1000	3,300	3,700	4,300	4,600
1100	3,500	4,000	4,600	4,900
1200	3,800	4,300	5,000	5,400
1300	4,000	4,600	5,300	5,700
1400	4,200	4,800	5,500	5,900
1500	4,400	5,000	5,800	6,200
1600	4,700	5,400	6,200	6,700
1700	5,100	5,900	6,800	7,300
1800	5,300	6,100	7,000	7,500
1900	5,500	6,300	7,300	7,800
2000	5,700	6,600	7,600	8,100
2100	6,000	6,900	8,000	8,600
2200	6,200	7,200	8,200	8,800
2300	6,400	7,400	8,500	9,100
2400	6,600	7,600	8,800	9,400

- 18メッシュ以外の場合は、お問い合わせください。
- 中棧による網の分け張りは実費¥200 アップになります。
- 取替ゴムの特寸タイプは実費でいただきます。(4.8・5.0φ以外)
- 網戸のW、Hの切断、戸車振れ止めの交換は実費でいただきます。
- 網戸の洗浄指定の場合は実費¥100いただきます。

(注意) 表示価格は製品価格で運搬費、現場採寸費用、取付費、消費税等は含まれておりません。

網戸張り替え定価表
レックスネット18メッシュ

W寸 H寸	930マデ	931~1,300	1,031~1,350	1,351以上
400	1,500	1,600	2,000	2,200
500	1,600	1,800	2,200	2,300
600	1,800	1,900	2,400	2,600
700	1,900	2,100	2,600	2,800
800	2,000	2,300	2,700	2,900
900	2,100	2,500	2,800	3,000
1000	2,200	2,600	3,000	3,200
1100	2,400	2,800	3,200	3,500
1200	2,600	3,000	3,500	3,800
1300	2,700	3,100	3,600	3,900
1400	2,800	3,300	3,800	4,100
1500	3,000	3,500	4,100	4,400
1600	3,100	3,600	4,200	4,500
1700	3,200	3,800	4,300	4,600
1800	3,500	4,100	4,700	5,100
1900	3,600	4,200	4,900	5,200
2000	3,700	4,400	5,000	5,400
2100	3,900	4,600	5,300	5,700
2200	4,000	4,700	5,400	5,800
2300	4,200	4,900	5,700	6,100
2400	4,400	5,100	5,900	6,400

- 18メッシュ以外の場合は、お問い合わせください。

- 中棧による網の分け張りは実費¥200 アップになります。

- 取替ゴムの特寸タイプは実費でいただきます。(4.8・5.0Φ以外)

- 網戸のW、Hの切断、戸車振れ止めの交換は実費でいただきます。

- 網戸の洗浄指定の場合は実費¥100いただきます。

(注意) 表示価格は製品価格で運搬費、現場採寸費用、取付費、消費税等は含まれておりません。

網戸張り替え定価表
ビニールネット18メッシュ（グレー・ブラック）

W寸 H寸	930マデ	931～1,300	1,031～1,350	1,351以上
400	1,100	1,300	1,500	1,600
500	1,200	1,400	1,600	1,700
600	1,300	1,500	1,800	1,900
700	1,400	1,600	1,900	2,000
800	1,500	1,700	2,000	2,200
900	1,600	1,800	2,200	2,300
1000	1,700	1,900	2,300	2,500
1100	1,900	2,200	2,600	2,800
1200	2,000	2,300	2,700	2,900
1300	2,100	2,400	2,800	3,000
1400	2,200	2,600	3,000	3,200
1500	2,300	2,700	3,100	3,300
1600	2,400	2,800	3,200	3,500
1700	2,500	2,900	3,400	3,600
1800	2,600	3,000	3,500	3,800
1900	2,700	3,100	3,600	3,900
2000	2,800	3,200	3,800	4,100
2100	2,900	3,300	3,900	4,200
2200	3,000	3,400	4,100	4,400
2300	3,100	3,500	4,200	4,500
2400	3,200	3,600	4,300	4,600

- 18メッシュ以外の場合は、お問い合わせください。
- 中棧による網の分け張りは実費¥200 アップになります。
- 取替ゴムの特寸タイプは実費でいただきます。（4.8・5.0Φ以外）
- 網戸のW、Hの切断、戸車振れ止めの交換は実費でいただきます。
- 網戸の洗浄指定の場合は実費¥100いただきます。

（注意）表示価格は製品価格で運搬費、現場採寸費用、取付費、消費税等は含まれておりません。

【オーダー網戸】

※内観図(左住宅用、右ビル用)

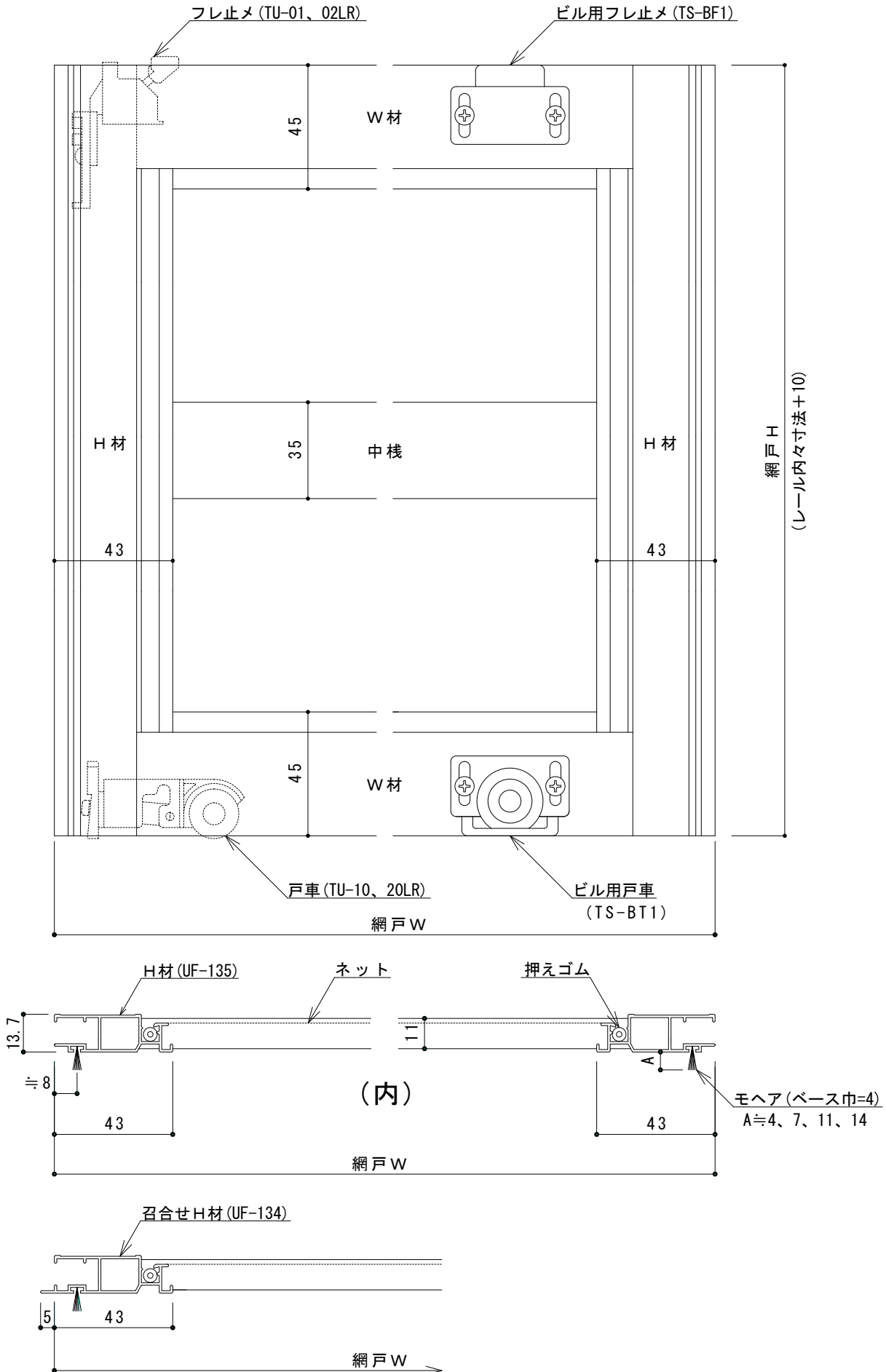

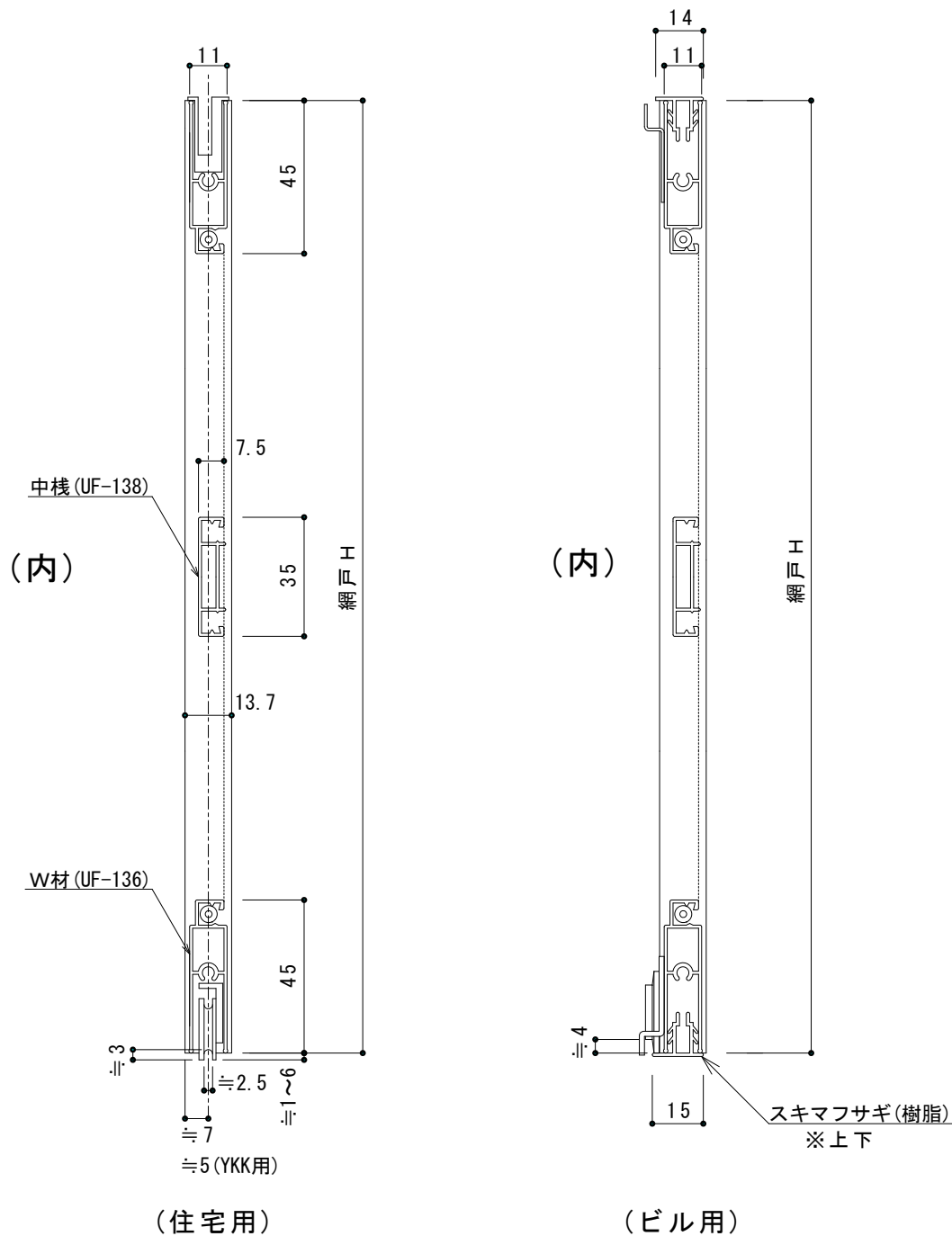

(使用型材)

W材 (UF-136)	H材 (UF-135)	召合せH材 (UF-134)	中棧 (UF-138)

(カラーバリエーション) シルバー、ブロンズ、ブラック、ステンカラー、ホワイト色

ビニールネット網戸定価表
(18メッシュ)

シルバー

W寸 H寸	~400	~500	~600	~700	~800	~900	~940	~1000
~400	3,600	3,900	4,100	4,400	4,800	5,100	5,300	5,600
401~500	3,800	4,100	4,400	4,800	5,100	5,400	5,700	5,900
501~600	4,100	4,400	4,800	5,100	5,400	5,800	6,000	6,200
601~700	4,300	4,800	5,000	5,400	5,700	6,100	6,300	6,500
701~800	4,800	5,100	5,300	5,800	6,200	6,400	6,700	6,900
801~900	5,100	5,600	5,800	6,100	6,400	6,900	7,100	7,500
901~1000	5,600	6,100	6,300	6,900	7,200	7,500	7,900	8,100
1001~1100	6,100	6,500	6,800	7,200	7,700	8,000	8,200	8,400
1101~1200	6,400	6,800	7,100	7,500	8,000	8,300	8,500	8,800
1201~1300	6,700	7,200	7,400	8,000	8,300	8,700	8,900	9,100
1301~1400	7,000	7,500	7,800	8,300	8,700	9,000	9,300	9,500
1401~1500	7,400	7,900	8,100	8,700	9,000	9,300	9,700	9,900
1501~1600	7,800	8,200	8,400	9,000	9,300	9,700	10,000	10,200
1601~1700	8,100	8,700	9,000	9,500	9,900	10,300	10,700	10,900
1701~1800	8,500	9,000	9,300	9,900	10,300	10,800	11,000	11,400
1801~1900			9,600	10,200	10,800	11,200	11,500	12,000
1901~2000			10,200	10,800	11,300	11,800	12,100	12,700
2001~2100			10,800	11,400	11,900	12,400	12,800	13,300
2101~2200			11,400	12,000	12,500	13,100	13,400	14,000
2201~2300			12,000	12,700	13,200	13,800	14,200	14,800

W寸 H寸	~1100	~1200	~1360
1801~1900	12,400	13,800	15,100
1901~2000	13,100	14,500	15,900
2001~2100	13,800	15,300	16,800
2101~2200	14,500	16,100	17,700
2201~2300	15,300	17,000	18,600

□ 18メッシュ以外の場合は、お問い合わせください。

(注意) 表示価格は製品価格で運搬費、現場採寸費用、取付費、消費税等は含まれておりません。

ビニールネット網戸定価表
(18メッシュ)

ブロンズ

W寸 \ H寸	~400	~500	~600	~700	~800	~900	~940	~1000
~400	4,000	4,300	4,600	4,900	5,300	5,700	5,900	6,200
401~500	4,200	4,600	4,900	5,300	5,700	6,000	6,300	6,500
501~600	4,600	4,900	5,300	5,700	6,000	6,400	6,700	6,900
601~700	4,800	5,300	5,600	6,000	6,300	6,800	7,000	7,200
701~800	5,300	5,700	5,900	6,400	6,900	7,100	7,400	7,700
801~900	5,700	6,200	6,400	6,800	7,100	7,700	7,900	8,300
901~1000	6,200	6,800	7,000	7,700	8,000	8,300	8,800	9,000
1001~1100	6,800	7,200	7,500	8,000	8,500	8,900	9,100	9,300
1101~1200	7,100	7,500	7,900	8,300	8,900	9,200	9,400	9,800
1201~1300	7,400	8,000	8,200	8,900	9,200	9,700	9,900	10,100
1301~1400	7,800	8,300	8,700	9,200	9,700	10,000	10,300	10,500
1401~1500	8,200	8,800	9,000	9,600	10,000	10,300	10,800	11,000
1501~1600	8,700	9,100	9,300	10,000	10,300	10,800	11,100	11,300
1601~1700	9,000	9,600	10,000	10,500	11,000	11,400	11,900	12,100
1701~1800	9,400	10,000	10,300	11,000	11,400	12,000	12,200	12,700
1801~1900			10,700	11,300	12,000	12,400	12,800	13,300
1901~2000			11,300	12,000	12,500	13,100	13,400	14,100
2001~2100			12,000	12,700	13,200	13,800	14,200	14,800
2101~2200			12,700	13,300	13,900	14,500	14,900	15,500
2201~2300			13,300	14,100	14,700	15,300	15,800	16,400

W寸 \ H寸	~1100	~1200	~1360
1801~1900	13,800	15,300	16,800
1901~2000	14,500	16,100	17,700
2001~2100	15,300	17,000	18,600
2101~2200	16,100	17,900	19,600
2201~2300	17,000	18,900	20,600

□ 18メッシュ以外の場合は、お問い合わせください。

(注意) 表示価格は製品価格で運搬費、現場採寸費用、取付費、消費税等は含まれておりません。

ビニールネット網戸定価表

(18メッシュ)

ブラック・ホワイト・ステンカラー

W寸 H寸	~400	~500	~600	~700	~800	~900	~940	~1000
~400	4,100	4,500	4,700	5,100	5,500	5,900	6,100	6,400
401~500	4,400	4,700	5,100	5,500	5,900	6,200	6,600	6,800
501~600	4,700	5,100	5,500	5,900	6,200	6,700	6,900	7,100
601~700	4,900	5,500	5,800	6,200	6,600	7,000	7,200	7,500
701~800	5,500	5,900	6,100	6,700	7,100	7,400	7,700	7,900
801~900	5,900	6,400	6,700	7,000	7,400	7,900	8,200	8,600
901~1000	6,400	7,000	7,200	7,900	8,300	8,600	9,100	9,300
1001~1100	7,000	7,500	7,800	8,300	8,900	9,200	9,400	9,700
1101~1200	7,400	7,800	8,200	8,600	9,200	9,500	9,800	10,100
1201~1300	7,700	8,300	8,500	9,200	9,500	10,000	10,200	10,500
1301~1400	8,100	8,600	9,000	9,500	10,000	10,400	10,700	10,900
1401~1500	8,500	9,100	9,300	10,000	10,400	10,700	11,200	11,400
1501~1600	9,000	9,400	9,700	10,400	10,700	11,200	11,500	11,700
1601~1700	9,300	10,000	10,400	10,900	11,400	11,800	12,300	12,500
1701~1800	9,800	10,400	10,700	11,400	11,800	12,400	12,700	13,100
1801~1900			11,000	11,700	12,400	12,900	13,200	13,800
1901~2000			11,700	12,400	13,000	13,600	13,900	14,600
2001~2100			12,400	13,100	13,700	14,300	14,700	15,300
2101~2200			13,100	13,800	14,400	15,100	15,400	16,100
2201~2300			13,800	14,600	15,200	15,900	16,300	17,000

W寸 H寸	~1100	~1200	~1360
1801~1900	14,300	15,900	17,400
1901~2000	15,100	16,700	18,300
2001~2100	15,900	17,600	19,300
2101~2200	16,700	18,500	20,400
2201~2300	17,600	19,600	21,400

□ 18メッシュ以外の場合は、お問い合わせください。

(注意) 表示価格は製品価格で運搬費、現場採寸費用、取付費、消費税等は含まれておりません。

ステンネット網戸定価表
(18メッシュ)

シルバー

W寸 \ H寸	~400	~500	~600	~700	~800	~900	~940	~1000
~400	5,200	5,500	5,700	6,100	6,400	6,700	6,900	7,200
401~500	5,600	6,000	6,200	6,700	7,000	7,300	7,600	7,800
501~600	6,300	6,600	6,900	7,300	7,600	7,900	8,100	8,400
601~700	6,700	7,200	7,400	7,900	8,200	8,500	8,800	9,000
701~800	7,500	7,800	8,000	8,500	8,900	9,100	9,400	9,600
801~900	8,100	8,500	8,700	9,100	9,400	9,800	10,100	10,500
901~1000	8,800	9,400	9,600	10,100	10,500	10,800	11,100	11,300
1001~1100	9,600	10,000	10,300	10,700	11,200	11,500	11,700	11,900
1101~1200	10,200	10,600	10,900	11,300	11,800	12,100	12,300	12,500
1201~1300	10,700	11,300	11,600	12,000	12,400	12,700	12,900	13,100
1301~1400	11,300	11,900	12,100	12,700	13,000	13,300	13,600	13,900
1401~1500	12,000	12,500	12,700	13,300	13,600	13,900	14,200	14,500
1501~1600	12,700	13,100	13,300	13,900	14,200	14,500	14,900	15,100
1601~1700	13,300	13,800	14,100	14,700	15,000	15,500	15,800	16,000
1701~1800	14,000	14,400	14,700	15,300	15,700	16,200	16,400	16,800
1801~1900				16,100	16,600	17,200	17,700	18,300
1901~2000				16,900	17,500	18,000	18,600	19,100
2001~2100				17,800	18,400	19,000	19,600	20,100
2101~2200				18,800	19,400	20,000	20,600	21,600
2201~2300				19,800	20,400	21,100	21,700	22,900

W寸 \ H寸	~1100	~1200	~1360
1801~1900	19,700	20,700	22,300
1901~2000	20,800	21,700	23,500
2001~2100	21,900	22,900	24,800
2101~2200	23,300	24,100	26,100
2201~2300	24,600	25,400	27,500

□ 18メッシュ以外の場合は、お問い合わせください。

(注意) 表示価格は製品価格で運搬費、現場採寸費用、取付費、消費税等は含まれておりません。

ステンレスネット網戸定価表
(18メッシュ)

ブロンズ

W寸 \ H寸	~400	~500	~600	~700	~800	~900	~940	~1000
~400	5,700	6,100	6,300	6,700	7,000	7,400	7,600	7,900
401~500	6,200	6,600	6,800	7,400	7,700	8,000	8,400	8,600
501~600	6,900	7,300	7,600	8,000	8,400	8,700	8,900	9,200
601~700	7,400	7,900	8,100	8,700	9,000	9,400	9,700	9,900
701~800	8,300	8,600	8,800	9,400	9,800	10,000	10,300	10,600
801~900	8,900	9,400	9,600	10,000	10,300	10,800	11,100	11,600
901~1000	9,700	10,300	10,600	11,100	11,600	11,900	12,200	12,400
1001~1100	10,600	11,000	11,300	11,800	12,300	12,700	12,900	13,100
1101~1200	11,200	11,700	12,000	12,400	13,000	13,300	13,500	13,800
1201~1300	11,800	12,400	12,800	13,200	13,600	14,000	14,200	14,400
1301~1400	12,400	13,100	13,300	14,000	14,300	14,600	15,000	15,300
1401~1500	13,200	13,800	14,000	14,600	15,000	15,300	15,600	16,000
1501~1600	14,000	14,400	14,600	15,300	15,600	16,000	16,400	16,600
1601~1700	14,600	15,200	15,500	16,200	16,500	17,100	17,400	17,600
1701~1800	15,400	15,800	16,200	16,800	17,300	17,800	18,000	18,500
1801~1900				17,700	18,300	18,900	19,500	20,100
1901~2000				18,600	19,300	19,800	20,500	21,000
2001~2100				19,600	20,200	20,900	21,600	22,100
2101~2200				20,700	21,300	22,000	22,700	23,800
2201~2300				21,800	22,400	23,200	23,900	25,200

W寸 \ H寸	~1100	~1200	~1360
1801~1900	21,700	22,800	24,500
1901~2000	22,900	23,900	25,900
2001~2100	24,100	25,200	27,300
2101~2200	25,600	26,500	28,700
2201~2300	27,100	28,000	30,300

□ 18メッシュ以外の場合は、お問い合わせください。

(注意) 表示価格は製品価格で運搬費、現場採寸費用、取付費、消費税等は含まれておりません。

ステンレスネット網戸定価表

(18メッシュ)

ブラック・ホワイト・ステンカラー

W寸 H寸	~400	~500	~600	~700	~800	~900	~940	~1000
~400	6,000	6,300	6,600	7,000	7,400	7,700	7,900	8,300
401~500	6,500	6,900	7,100	7,700	8,100	8,400	8,700	9,000
501~600	7,200	7,600	7,900	8,400	8,700	9,100	9,300	9,700
601~700	7,700	8,300	8,500	9,100	9,400	9,800	10,100	10,400
701~800	8,600	9,000	9,200	9,800	10,200	10,500	10,800	11,000
801~900	9,300	9,800	10,000	10,500	10,800	11,300	11,600	12,100
901~1000	10,100	10,800	11,000	11,600	12,100	12,400	12,800	13,000
1001~1100	11,000	11,500	11,800	12,300	12,900	13,200	13,500	13,700
1101~1200	11,700	12,200	12,500	13,000	13,600	13,900	14,100	14,400
1201~1300	12,300	13,000	13,300	13,800	14,300	14,600	14,800	15,100
1301~1400	13,000	13,700	13,900	14,600	15,000	15,300	15,600	16,000
1401~1500	13,800	14,400	14,600	15,300	15,600	16,000	16,300	16,700
1501~1600	14,600	15,100	15,300	16,000	16,300	16,700	17,100	17,400
1601~1700	15,300	15,900	16,200	16,900	17,300	17,800	18,200	18,400
1701~1800	16,100	16,600	16,900	17,600	18,100	18,600	18,900	19,300
1801~1900				18,500	19,100	19,800	20,400	21,000
1901~2000				19,400	20,100	20,700	21,400	22,000
2001~2100				20,500	21,200	21,900	22,500	23,100
2101~2200				21,600	22,300	23,000	23,700	24,800
2201~2300				22,800	23,500	24,300	25,000	26,300

W寸 H寸	~1100	~1200	~1360
1801~1900	22,700	23,800	25,600
1901~2000	23,900	25,000	27,000
2001~2100	25,200	26,300	28,500
2101~2200	26,800	27,700	30,000
2201~2300	28,300	29,200	31,600

□ 18メッシュ以外の場合は、お問い合わせください。

(注意) 表示価格は製品価格で運搬費、現場採寸費用、取付費、消費税等は含まれておりません。

【フクロ網戸】

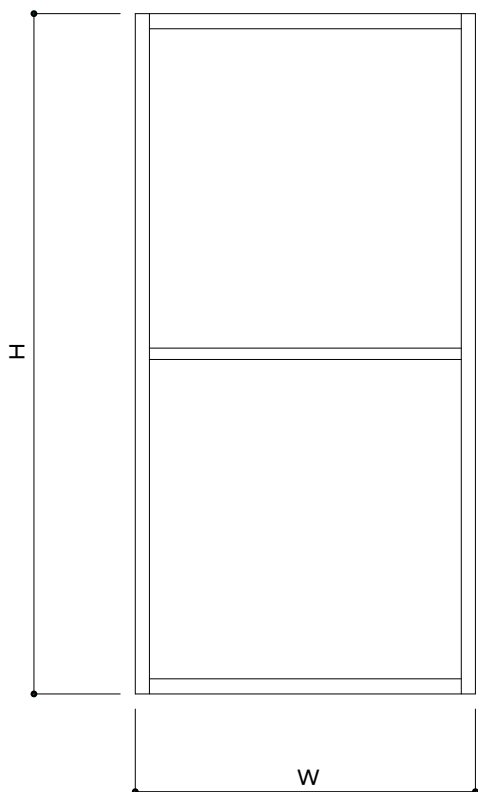

(定価表) 色=シルバー、ブロンズ ネット=ビニール

W×H	定 価
900×900	¥14,300
900×1,350	¥16,500
900×1,800	¥18,700
900×1,900	¥19,800
900×2,000	¥20,900
900×2,100	¥23,100

*表示価格は製品定価で運搬費、採寸費、取付費、消費税は含まれておりません。

(使用型材)

W材	H材	中 棧
<p>Diagram of the W material cross-section. It shows a U-shaped profile with a top flange of 35mm, a total height of 40mm, and a bottom flange of 27mm.</p>	<p>Diagram of the H material cross-section. It shows a U-shaped profile with a top flange of 7mm, a top width of 24mm, a total height of 36.4mm, and a bottom flange of 25mm.</p>	<p>Diagram of the middle rail cross-section. It shows a rectangular profile with a width of 7.5mm and a height of 30mm.</p>

(H寸法の測り方)

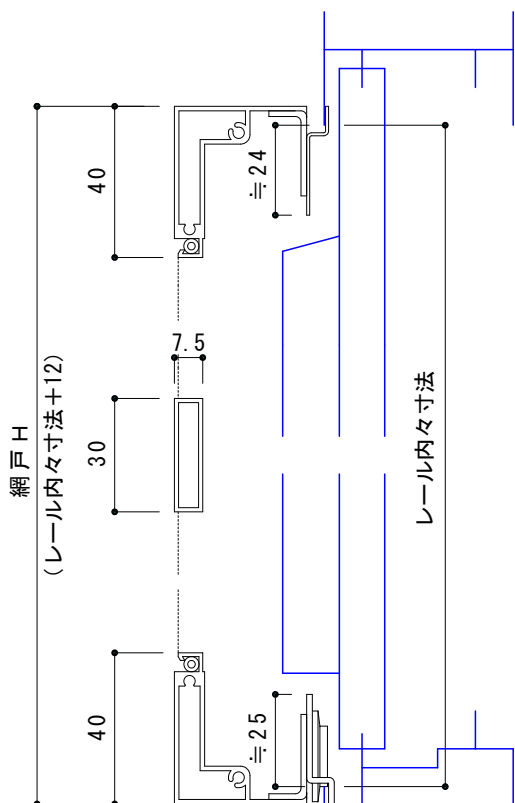

※レール内々寸法+12mmがH仕上がり寸法

※中棧の位置も測って下さい。

(W寸法の測り方)

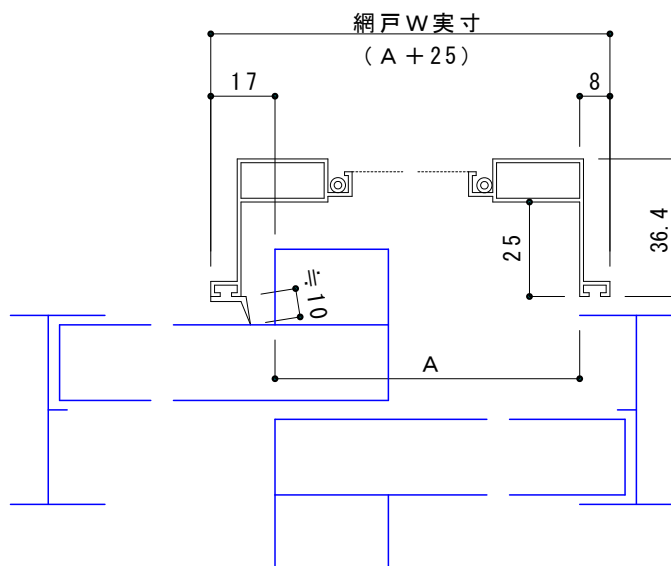

※ A 寸法 + 25mm が W 仕上がり寸法

※内観右側のみ網戸使用可能

【固定網戸】

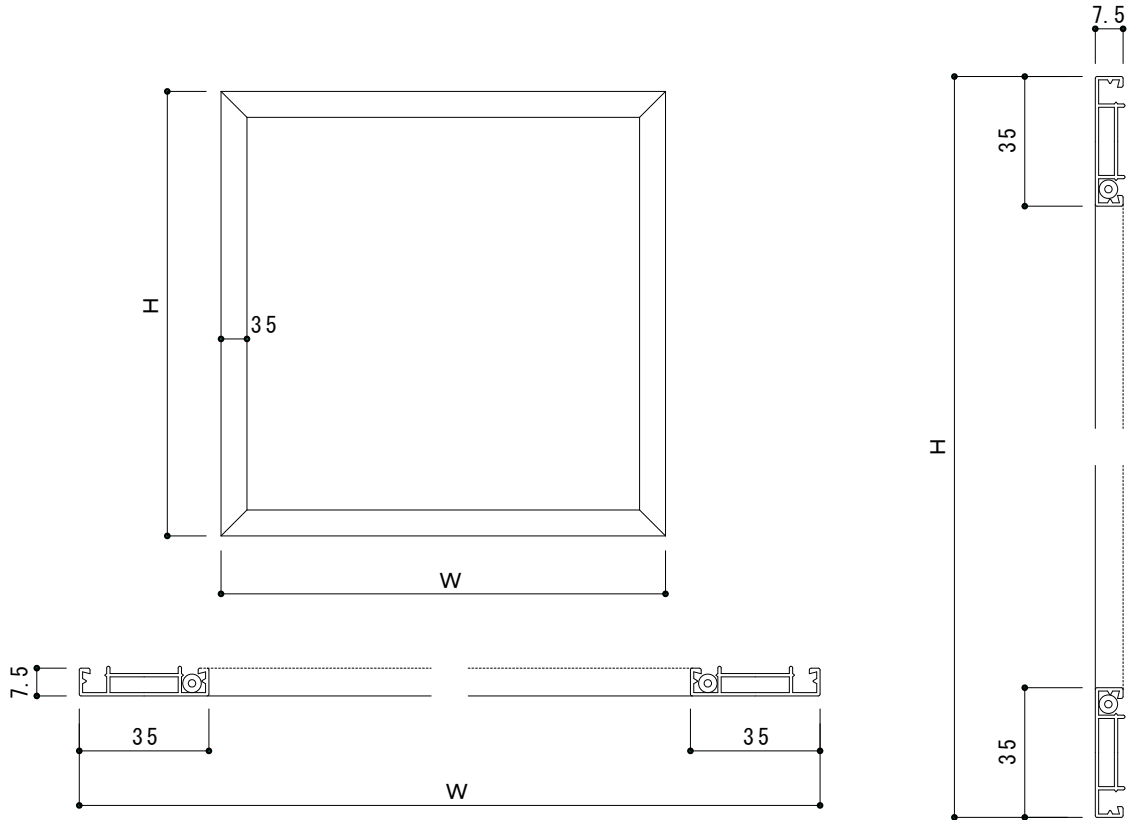

(使用型材、部品)

網戸中棧 (UF-138)	ステンL金具

(定価表)

シルバー、ブロンズ、ブラック、ステンカラー、ホワイト共通価格

ネット	W		500	600	700	800	900	1,000
	H							
ビニール	700		8,400	8,700	9,000	9,400	10,000	10,300
ステン			9,900	10,300	11,000	11,300	11,900	12,700
ビニール	800		8,700	9,000	9,400	10,000	10,300	10,700
ステン			10,500	10,800	11,300	11,800	12,300	13,200
ビニール	900		9,000	9,400	10,000	10,300	10,700	11,300
ステン			11,000	11,300	11,900	12,300	12,900	13,900
ビニール	1,000		9,400	9,700	10,300	10,700	11,000	11,700
ステン			11,500	11,900	12,700	13,200	13,400	14,600
ビニール	1,100		9,700	10,000	10,500	11,000	11,300	12,000
ステン			12,100	12,400	13,000	13,400	13,900	15,100
ビニール	1,200		10,000	10,300	11,000	11,300	11,700	12,300
ステン			12,500	13,000	13,500	13,900	14,200	15,400
ビニール	1,300		10,300	10,700	11,000	11,700	12,000	12,700
ステン			13,200	13,500	14,000	14,400	14,800	16,100

*表示価格は製品定価で運搬費、採寸費、取付費、消費税は含まれておりません。

【オーダー面格子】

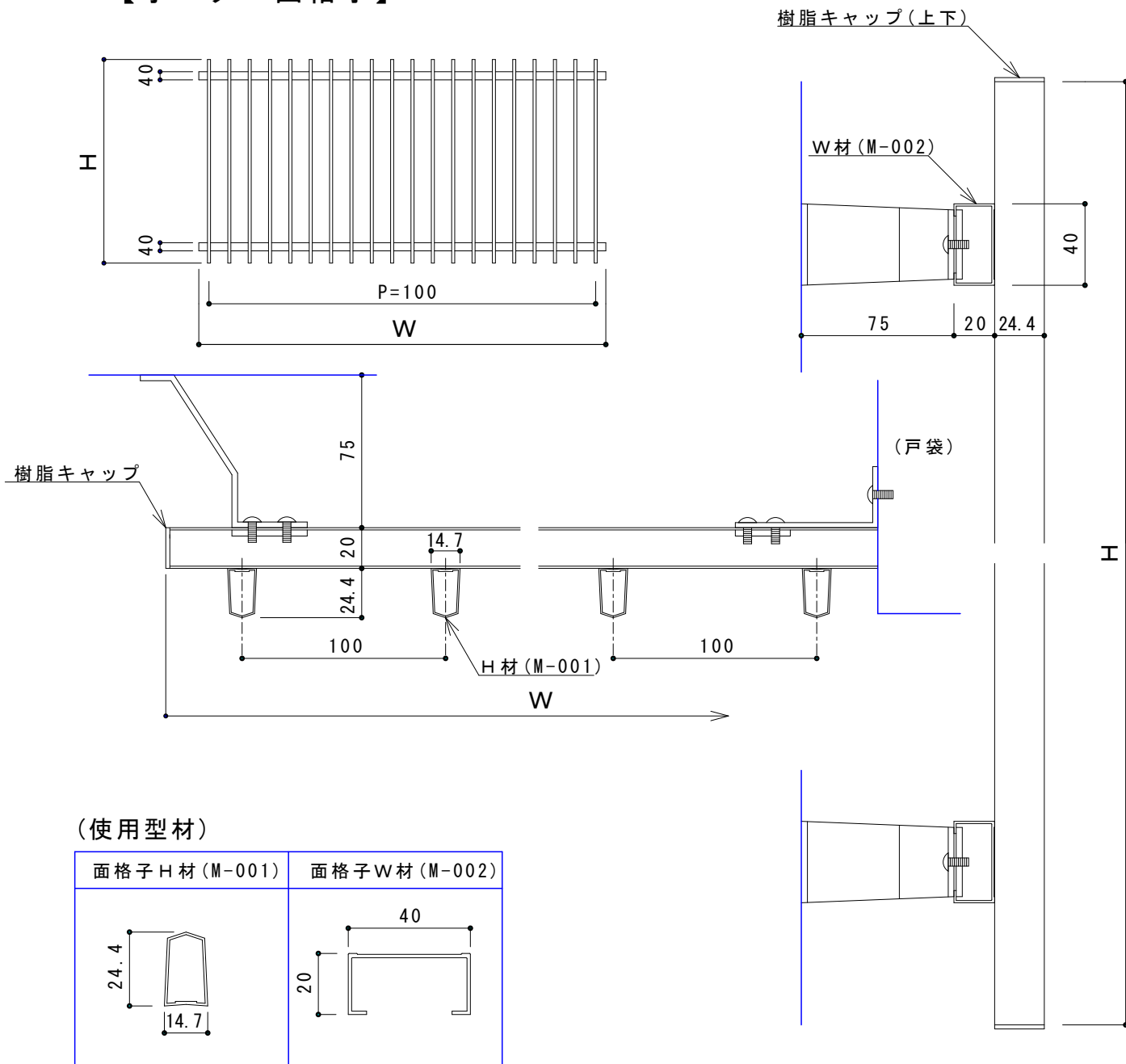

(使用型材)

面格子H材 (M-001)	面格子W材 (M-002)

(取付けブラケット)

アルミBL100用	アルミBL75用	ステンワンタッチBL60用	ステンワンタッチBL30用	戸袋用ブラケット

(カラーバリエーション) シルバー、ブロンズ、ブラック、ステンカラー、ホワイト、オータムブラウン

面 格 子 定 価 表

シルバー

W \ H	840	900	940	1,000	1,050	1,120	1,200	1,250	1,300	1,360	1,400	1,450	1,550	1,600	1,650	1,700	1,750
400	6,400	6,600	6,800	7,000	7,400	7,800	8,400	8,700	9,000	9,600	9,900	10,200	10,700	11,300	11,800	12,300	12,500
500	6,900	7,100	7,500	7,700	8,000	8,500	9,000	9,600	9,900	10,300	10,700	11,000	11,800	12,200	12,700	13,200	13,400
600	7,600	7,900	8,200	8,400	8,800	9,500	9,900	10,500	10,900	11,300	11,800	12,000	12,700	13,200	13,900	14,600	14,800
700	8,000	8,400	8,700	8,900	9,500	9,900	10,300	11,200	11,700	12,000	12,600	12,800	13,400	13,800	14,400	15,100	15,300
800	8,700	9,100	9,600	9,800	10,200	10,500	10,800	12,200	12,700	13,100	13,700	13,900	14,200	14,500	15,200	16,000	16,200
900	9,100	9,600	10,000	10,200	10,600	11,200	11,800	12,700	13,100	13,800	14,200	14,500	15,200	16,100	16,400	17,400	17,600
1,000	9,700	10,100	10,500	10,700	11,200	12,000	12,700	13,300	13,900	14,900	15,100	15,400	16,400	16,900	17,600	18,700	18,900
1,100	10,300	10,700	11,200	11,400	12,000	12,700	13,400	14,300	14,800	15,400	16,000	16,300	17,500	18,000	18,800	19,500	20,000
1,200	10,900	11,400	12,000	12,200	12,700	13,600	14,500	15,200	15,900	16,400	17,000	17,400	18,700	20,200	21,100	21,800	22,100
1,300	11,800	12,300	12,800	13,000	13,700	14,600	15,500	16,200	16,900	17,200	18,100	18,700	19,800	20,700	21,400	22,800	23,000
1,400	12,600	13,000	13,800	14,000	14,600	15,600	16,700	17,000	17,600	18,100	19,300	20,100	21,400	22,200	22,900	24,600	24,900
1,500	13,200	14,000	14,500	14,700	15,400	16,700	17,700	18,400	18,800	19,200	20,600	21,300	22,900	23,600	24,400	25,600	26,100
1,600	13,900	14,700	15,200	16,000	16,700	18,000	19,100	19,800	20,500	21,200	22,300	23,000	24,700	25,400	26,300	27,300	28,000
1,700	14,500	15,500	15,900	17,100	17,900	19,100	20,400	21,300	22,100	23,100	23,800	24,700	26,400	27,200	28,000	28,900	29,900
1,800	14,700	15,800	16,500	17,500	18,300	19,600	21,000	21,800	22,800	23,800	24,400	25,300	27,100	27,800	28,900	29,600	30,700

W \ H	1,810	1,900	2,000	2,100	2,200	2,300	2,400	2,500	2,600	2,700	2,800	2,900	3,100	3,400	3,600	3,700	4,000
400	12,700	13,300	13,900	15,000	16,000	16,800	17,500	18,400	18,900	19,100	19,500	20,400	21,600	25,100	25,800	26,300	27,300
500	13,500	14,400	15,000	16,500	17,300	18,200	18,700	19,100	20,200	20,400	21,100	21,800	23,300	27,000	27,900	28,200	29,600
600	15,000	15,800	16,500	17,900	18,800	19,500	20,400	21,100	22,400	22,600	23,000	23,800	25,500	29,500	30,500	31,000	32,400
700	15,400	16,600	17,500	19,100	19,800	20,800	21,500	22,400	23,300	23,500	23,800	24,800	26,500	30,700	32,000	32,800	34,700
800	16,300	17,600	19,100	20,600	21,500	22,300	23,100	23,800	24,600	24,800	25,100	25,900	27,800	32,200	34,000	34,800	37,600
900	17,700	18,900	20,000	21,500	22,300	23,100	23,800	24,700	26,400	26,600	27,300	28,400	30,300	35,200	36,500	37,300	39,500
1,000	19,100	20,200	21,100	22,900	23,600	24,500	25,300	26,100	28,100	28,700	29,500	30,500	32,700	37,700	39,200	39,700	41,700
1,100	20,400	21,300	22,400	24,000	24,900	25,600	26,500	27,300	29,900	30,600	31,300	32,300	34,500	40,200	41,600	42,200	44,200
1,200	21,600	21,800	23,900	25,600	26,500	27,300	28,100	28,900	31,600	32,700	33,500	34,500	37,000	42,900	44,400	45,200	47,400
1,300	23,400	24,600	25,700	27,600	28,500	29,200	30,100	31,000	33,800	35,000	36,000	36,800	39,900	46,300	48,000	48,600	50,900
1,400	25,400	26,300	27,600	29,600	30,500	31,200	32,100	32,900	35,800	37,500	38,500	40,000	42,600	49,700	51,300	52,100	54,500
1,500	26,700	28,000	29,300	31,100	32,000	32,900	33,600	34,700	38,000	39,700	41,100	42,500	45,400	52,300	54,200	55,000	58,100
1,600	28,600	30,100	31,600	33,700	34,700	35,400	36,200	36,900	40,600	42,300	43,900	45,600	48,700	54,800	57,300	58,600	62,500
1,700	30,500	32,200	33,900	36,100	37,000	37,800	38,600	39,400	43,200	44,900	46,700	48,500	52,100	57,200	60,500	62,100	66,900
1,800	31,300	33,100	34,900	37,300	37,800	38,600	39,400	40,200	44,200	46,100	47,900	49,700	53,400	58,200	61,700	63,500	68,700

(アルミブラケット付) * ステンブラケット別売

* 特寸 最大W5500×H5400まで製作出来ます。

(注意) 表示価格は製品価格で運搬費、現場採寸費、取付費、消費税は含まれておりません。

面 格 子 定 価 表

ブロンズ

W \ H	840	900	940	1,000	1,050	1,120	1,200	1,250	1,300	1,360	1,400	1,450	1,550	1,600	1,650	1,700	1,750
400	7,400	7,600	7,800	8,100	8,500	9,000	9,700	10,000	10,400	11,000	11,400	11,700	12,300	13,000	13,600	14,100	14,400
500	7,900	8,200	8,600	8,900	9,200	9,800	10,400	11,000	11,400	11,800	12,300	12,700	13,600	14,000	14,600	15,200	15,400
600	8,700	9,100	9,400	9,700	10,100	10,900	11,400	12,100	12,500	13,000	13,600	13,800	14,600	15,200	16,000	16,800	17,000
700	9,200	9,700	10,000	10,200	10,900	11,400	11,800	12,900	13,500	13,800	14,500	14,700	15,400	15,900	16,600	17,400	17,600
800	10,000	10,500	11,000	11,300	11,700	12,100	12,400	14,000	14,600	15,100	15,800	16,000	16,300	16,700	17,500	18,400	18,600
900	10,500	11,000	11,500	11,700	12,200	12,900	13,600	14,600	15,100	15,900	16,300	16,700	17,500	18,500	18,900	20,000	20,200
1,000	11,200	11,600	12,100	12,300	12,900	13,800	14,600	15,300	16,000	17,100	17,400	17,700	18,900	19,400	20,200	21,500	21,700
1,100	11,800	12,300	12,900	13,100	13,800	14,600	15,400	16,400	17,000	17,700	18,400	18,700	20,100	20,700	21,600	22,400	23,000
1,200	12,500	13,100	13,800	14,000	14,600	15,600	16,700	17,500	18,300	18,900	19,600	20,000	21,500	23,200	24,300	25,100	25,400
1,300	13,600	14,100	14,700	15,000	15,800	16,800	17,800	18,600	19,400	19,800	20,800	21,500	22,800	23,800	24,600	26,200	26,500
1,400	14,500	15,000	15,900	16,100	16,800	17,900	19,200	19,600	20,200	20,800	22,200	23,100	24,600	25,500	26,300	28,300	28,600
1,500	15,200	16,100	16,700	16,900	17,700	19,200	20,400	21,200	21,600	22,100	23,700	24,500	26,300	27,100	28,100	29,400	30,000
1,600	16,000	16,900	17,500	18,400	19,200	20,700	22,000	22,800	23,600	24,400	25,600	26,500	28,400	29,200	30,200	31,400	32,200
1,700	16,700	17,800	18,300	19,700	20,600	22,000	23,500	24,500	25,400	26,600	27,400	28,400	30,400	31,300	32,200	33,200	34,400
1,800	16,900	18,200	19,000	20,100	21,000	22,500	24,200	25,100	26,200	27,400	28,100	29,100	31,200	31,400	33,200	34,000	35,300

W \ H	1,810	1,900	2,000	2,100	2,200	2,300	2,400	2,500	2,600	2,700	2,800	2,900	3,100	3,400	3,600	3,700	4,000
400	14,600	15,300	16,000	17,300	18,400	19,300	20,100	21,200	21,700	22,000	22,400	23,500	24,800	28,900	29,700	30,200	31,400
500	15,500	16,600	17,300	19,000	19,900	20,900	21,500	22,000	23,200	23,500	24,300	25,100	26,800	31,100	32,100	32,400	34,000
600	17,300	18,200	19,000	20,600	21,600	22,400	23,500	24,300	25,800	26,000	26,500	27,400	29,300	33,900	35,100	35,700	37,300
700	17,700	19,100	20,100	22,000	22,800	23,900	24,700	25,800	26,800	27,000	27,400	28,500	30,500	35,300	36,800	37,700	39,900
800	18,700	20,200	22,000	23,700	24,700	25,600	26,600	27,400	28,300	28,500	28,900	29,800	32,000	37,000	39,100	40,000	43,200
900	20,400	21,700	23,000	24,700	25,600	26,600	27,400	28,400	30,400	30,600	31,400	32,700	34,800	40,500	42,000	42,900	45,400
1,000	22,000	23,200	24,300	26,300	27,100	28,200	29,100	30,000	32,300	33,000	33,900	35,100	37,600	43,400	45,100	45,700	48,000
1,100	23,500	24,500	25,800	27,600	28,600	29,400	30,500	31,400	34,400	35,200	36,000	37,100	39,700	46,200	47,800	48,500	50,800
1,200	24,800	25,100	27,500	29,400	30,500	31,400	32,300	33,200	36,300	37,600	38,500	39,700	42,600	49,300	51,100	52,000	54,500
1,300	26,900	28,300	29,600	31,700	32,800	33,600	34,600	35,700	38,900	40,300	41,400	42,300	45,900	53,200	55,200	55,900	58,500
1,400	29,200	30,200	31,700	34,000	35,100	35,900	36,900	37,800	41,200	43,100	44,300	46,000	49,000	57,200	59,000	59,900	62,700
1,500	30,700	32,200	33,700	35,800	36,800	37,800	38,600	39,900	43,700	45,700	47,300	48,900	52,200	60,100	62,300	63,300	66,800
1,600	32,900	34,600	36,300	38,800	39,900	40,700	41,600	42,400	46,700	48,600	50,500	52,400	56,000	63,000	65,900	67,400	71,900
1,700	35,100	37,000	39,000	41,500	42,600	43,500	44,400	45,300	49,700	51,600	53,700	55,800	59,900	65,800	69,600	71,400	76,900
1,800	36,000	38,100	40,100	42,900	43,500	44,400	45,300	46,200	50,800	53,000	55,100	57,200	61,400	66,900	71,000	73,000	79,000

(アルミブラケット付) * ステンブラケット別売

* 特寸 最大W5500×H5400まで製作出来ます。

(注意) 表示価格は製品価格で運搬費、現場採寸費、取付費、消費税は含まれておりません。

面 格 子 定 価 表

ブラック・ホワイト・ステンカラー

W H	840	900	940	1,000	1,050	1,120	1,200	1,250	1,300	1,360	1,400	1,450	1,550	1,600	1,650	1,700	1,750
400	8,100	8,400	8,600	8,900	9,400	9,900	10,700	11,000	11,400	12,200	12,600	13,000	13,600	14,400	15,000	15,600	15,900
500	8,800	9,000	9,500	9,800	10,200	10,800	11,400	12,200	12,600	13,100	13,600	14,000	15,000	15,500	16,100	16,800	17,000
600	9,700	10,000	10,400	10,700	11,200	12,100	12,600	13,300	13,800	14,400	15,000	15,200	16,100	16,800	17,700	18,500	18,800
700	10,200	10,700	11,000	11,300	12,100	12,600	13,100	14,200	14,900	15,200	16,000	16,300	17,000	17,500	18,300	19,200	19,400
800	11,000	11,600	12,200	12,400	13,000	13,300	13,700	15,500	16,100	16,600	17,400	17,700	18,000	18,400	19,300	20,300	20,600
900	11,600	12,200	12,700	13,000	13,500	14,200	15,000	16,100	16,600	17,500	18,000	18,400	19,300	20,400	20,800	22,100	22,400
1,000	12,300	12,800	13,300	13,600	14,200	15,200	16,100	16,900	17,700	18,900	19,200	19,600	20,800	21,500	22,400	23,700	24,000
1,100	13,100	13,600	14,200	14,500	15,200	16,100	17,000	18,200	18,800	19,600	20,300	20,700	22,200	22,900	23,900	24,800	25,400
1,200	13,800	14,500	15,200	15,500	16,100	17,300	18,400	19,300	20,200	20,800	21,600	22,100	23,700	25,700	26,800	27,700	28,100
1,300	15,000	15,600	16,300	16,500	17,400	18,500	19,700	20,600	21,500	21,800	23,000	23,700	25,100	26,300	27,200	29,000	29,200
1,400	16,000	16,500	17,500	17,800	18,500	19,800	21,200	21,600	22,400	23,000	24,500	25,500	27,200	28,200	29,100	31,200	31,600
1,500	16,800	17,800	18,400	18,700	19,600	21,200	22,500	23,400	23,900	24,400	26,200	27,100	29,100	30,000	31,000	32,500	33,100
1,600	17,700	18,700	19,300	20,300	21,200	22,900	24,300	25,100	26,000	26,900	28,300	29,200	31,400	32,300	33,400	34,700	35,600
1,700	18,400	19,700	20,200	21,700	22,700	24,300	25,900	27,100	28,100	29,300	30,200	31,400	33,500	34,500	35,600	36,700	38,000
1,800	18,700	20,100	21,000	22,200	23,200	24,900	26,700	27,700	29,000	30,200	31,000	32,100	34,400	34,700	36,700	37,600	39,000

W H	1,810	1,900	2,000	2,100	2,200	2,300	2,400	2,500	2,600	2,700	2,800	2,900	3,100	3,400	3,600	3,700	4,000
400	16,100	16,900	17,700	19,100	20,300	21,300	22,200	23,400	24,000	24,300	24,800	25,900	27,400	31,900	32,800	33,400	34,700
500	17,100	18,300	19,100	21,000	22,000	23,100	23,700	24,300	25,700	25,900	26,800	27,700	29,600	34,300	35,400	35,800	37,600
600	19,100	20,100	21,000	22,700	23,900	24,800	25,900	26,800	28,400	28,700	29,200	30,200	32,400	37,500	38,700	39,400	41,100
700	19,600	21,100	22,200	24,300	25,100	26,400	27,300	28,400	29,600	29,800	30,200	31,500	33,700	39,000	40,600	41,700	44,100
800	20,700	22,400	24,300	26,200	27,300	28,300	29,300	30,200	31,200	31,500	31,900	32,900	35,300	40,900	43,200	44,200	47,800
900	22,500	24,000	25,400	27,300	28,300	29,300	30,200	31,400	33,500	33,800	34,700	36,100	38,500	44,700	46,400	47,400	50,200
1,000	24,300	25,700	26,800	29,100	30,000	31,100	32,100	33,100	35,700	36,400	37,500	38,700	41,500	47,900	49,800	50,400	53,000
1,100	25,900	27,100	28,400	30,500	31,600	32,500	33,700	34,700	38,000	38,900	39,800	41,000	43,800	51,100	52,800	53,600	56,100
1,200	27,400	27,700	30,400	32,500	33,700	34,700	35,700	36,700	40,100	41,500	42,500	43,800	47,000	54,500	56,400	57,400	60,200
1,300	29,700	31,200	32,600	35,100	36,200	37,100	38,200	39,400	42,900	44,500	45,700	46,700	50,700	58,800	61,000	61,700	64,600
1,400	32,300	33,400	35,100	37,600	38,700	39,600	40,800	41,800	45,500	47,600	48,900	50,800	54,100	63,100	65,200	66,200	69,200
1,500	33,900	35,600	37,200	39,500	40,600	41,800	42,700	44,100	48,300	50,400	52,200	54,000	57,700	66,400	68,800	69,900	73,800
1,600	36,300	38,200	40,100	42,800	44,100	45,000	46,000	46,900	51,600	53,700	55,800	57,900	61,800	69,600	72,800	74,400	79,400
1,700	38,700	40,900	43,100	45,800	47,000	48,000	49,000	50,000	54,900	57,000	59,300	61,600	66,200	72,600	76,800	78,900	85,000
1,800	39,800	42,000	44,300	47,400	48,000	49,000	50,000	51,100	56,100	58,500	60,800	63,100	67,800	73,900	78,400	80,600	87,200

(アルミブラケット付) * ステンブラケット別売

* 特寸 最大W5500×H5400まで製作出来ます。

(注意) 表示価格は製品価格で運搬費、現場採寸費、取付費、消費税は含まれておりません。

面格子特寸タイプ定価表

シルバー

H \ W	300	400	500	600	700	800
400	4,400	4,800	5,300	5,600	5,900	6,200
500	4,800	5,400	5,700	6,000	6,400	6,700
600	5,500	5,900	6,200	6,500	6,900	7,200
700	6,000	6,400	6,700	7,000	7,400	7,700
800	6,400	6,800	7,100	7,600	7,900	8,200
900	6,700	7,100	7,500	7,900	8,300	8,700
1,000	7,000	7,400	7,800	8,200	8,700	9,100
1,100	7,800	8,100	8,600	9,000	9,500	9,900
1,200	8,100	8,500	9,000	9,700	10,000	10,500

ブロンズ

H \ W	300	400	500	600	700	800
400	5,100	5,500	6,100	6,400	6,800	7,100
500	5,500	6,200	6,600	6,900	7,400	7,700
600	6,300	6,800	7,100	7,500	7,900	8,300
700	6,900	7,400	7,700	8,100	8,500	8,900
800	7,400	7,800	8,200	8,700	9,100	9,400
900	7,700	8,200	8,600	9,100	9,500	10,000
1,000	8,100	8,500	9,000	9,400	10,000	10,500
1,100	9,000	9,300	9,900	10,400	10,900	11,400
1,200	9,300	9,800	10,400	11,200	11,500	12,100

ブラック・ホワイト・ステンカラー

H \ W	300	400	500	600	700	800
400	5,600	6,100	6,700	7,100	7,500	7,900
500	6,100	6,900	7,200	7,600	8,100	8,500
600	7,000	7,500	7,900	8,300	8,800	9,100
700	7,600	8,100	8,500	8,900	9,400	9,800
800	8,100	8,600	9,000	9,700	10,000	10,400
900	8,500	9,000	9,500	10,000	10,500	11,000
1,000	8,900	9,400	9,900	10,400	11,000	11,600
1,100	9,900	10,300	10,900	11,400	12,100	12,600
1,200	10,300	10,800	11,400	12,300	12,700	13,300

(アルミブラケット付) *ステンブラケット別売

(注意) 表示価格は製品価格で運搬費、現場採寸費、取付費、消費税は含まれておりません。

【ビル用面格子】

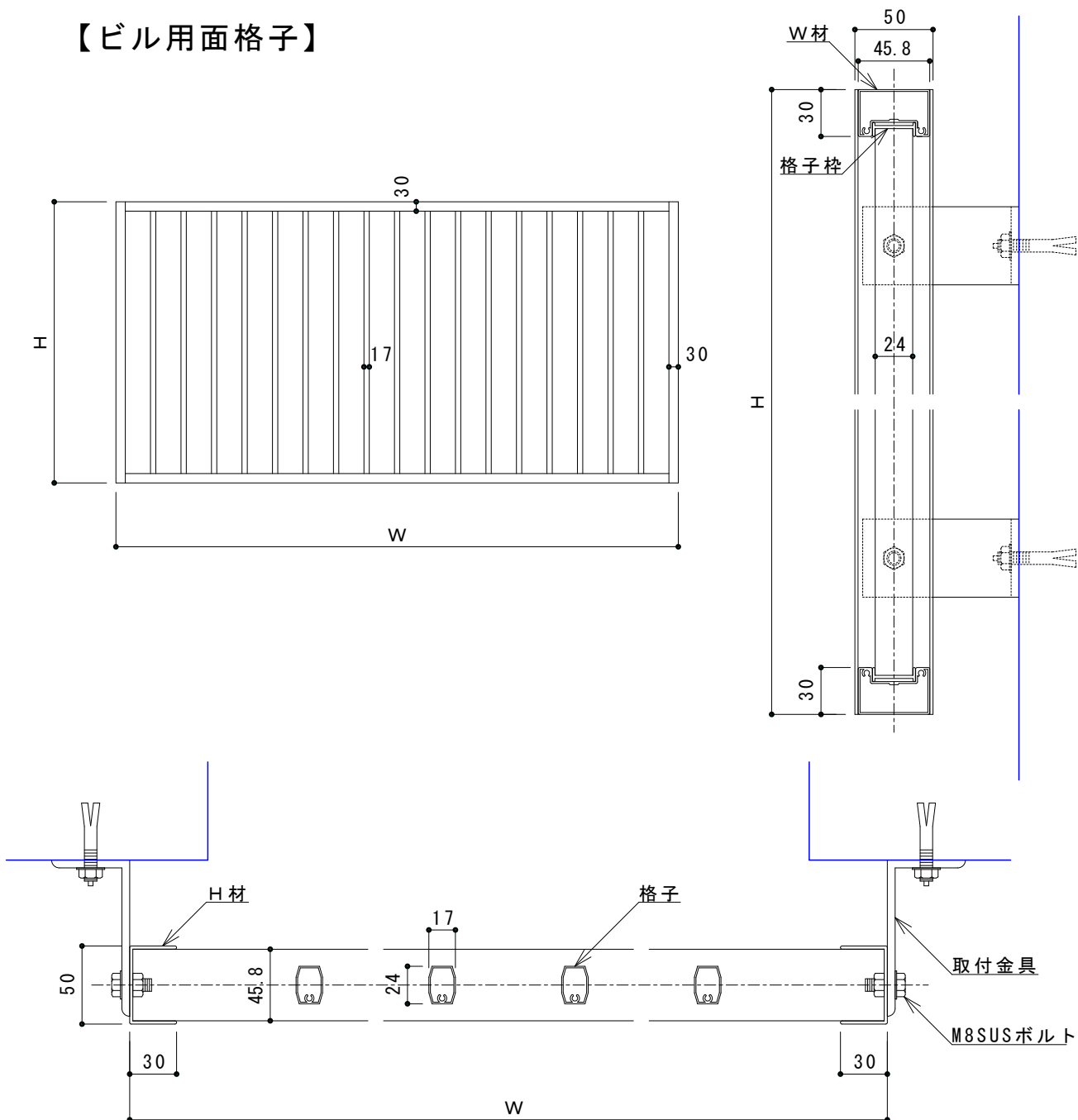

W材	H材	格子枠	格子

(カラーバリエーション) シルバー、ブロンズ、ブラック、ステンカラー、ホワイト

【クロス格子 ・ 井桁格子】

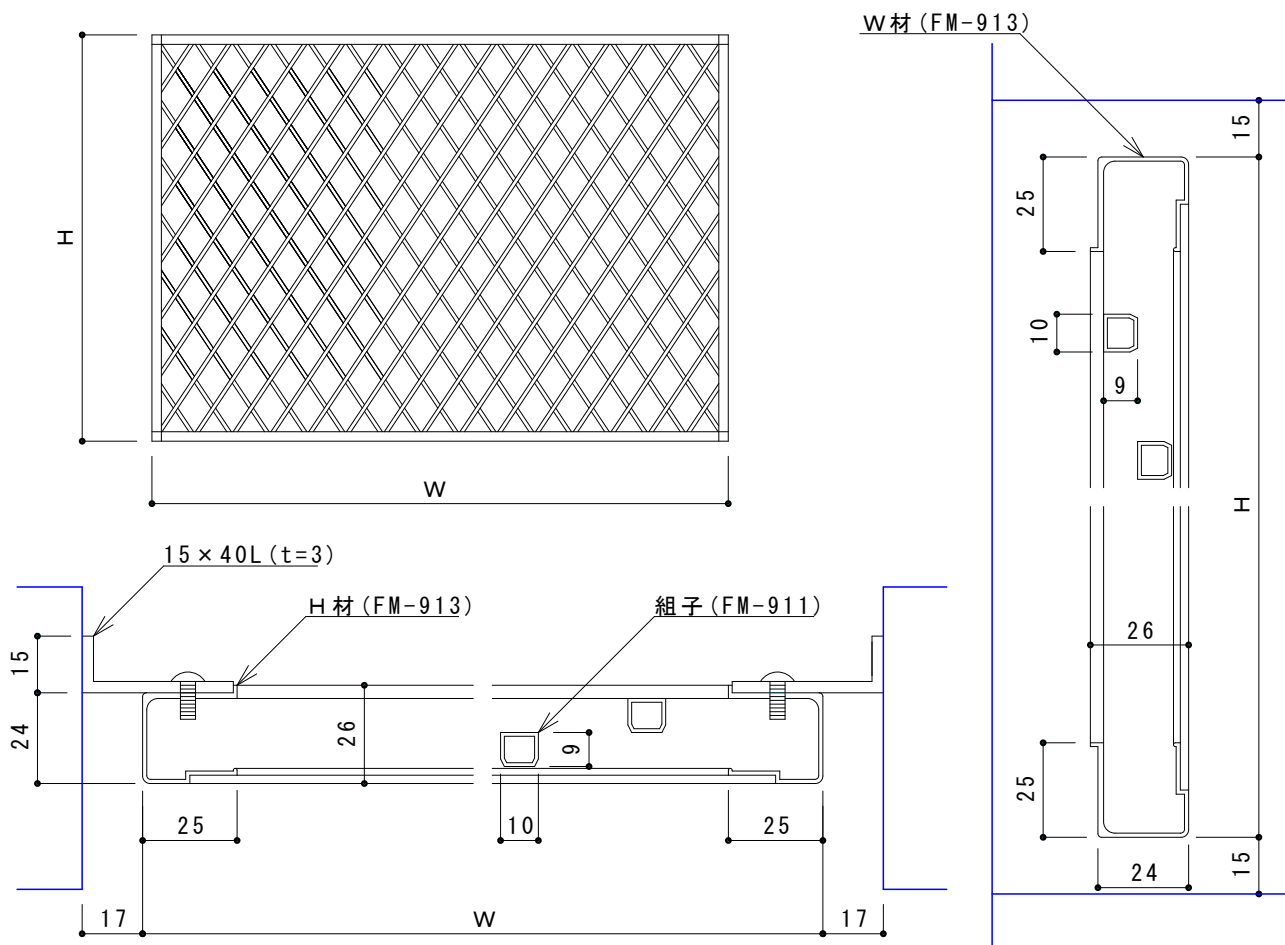

(ベランダ開口用)

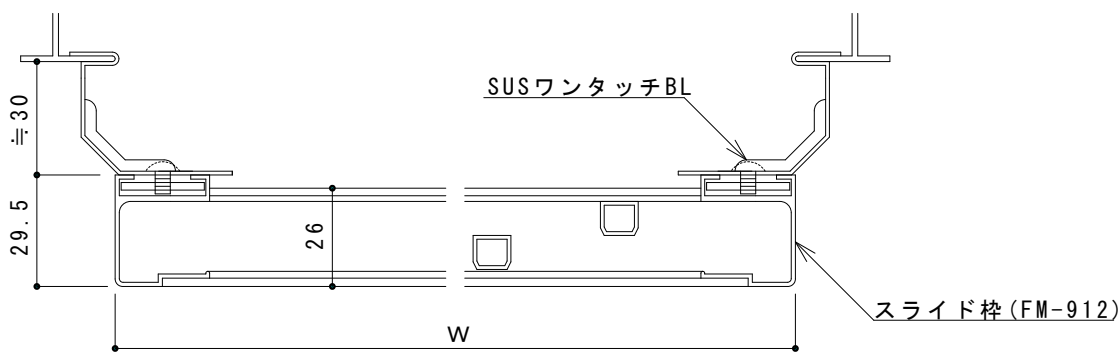

(※ヒレ内々寸法)

(面格子用)

(使用型材)

W、H材 (FM-913)	スライド枠 (FM-912)	組子 (FM-911)

(カラーバリエーション) シルバー、ブロンズ、ブラック、ステンカラー、ホワイト

クロス格子・井桁格子 定 価 表

シルバー・ブロンズ

W \ H	500	600	700	800	900	1,000	1,100	1,200	1,300	1,400	1,500	1,600	1,700	1,800	1,900	2,000
400	11,100	12,100	12,900	13,800	14,400	14,600	15,400	15,900	17,100	18,100	23,500	24,000	24,500	25,400	27,400	28,400
500	12,100	12,900	13,900	14,800	15,900	16,300	16,700	17,600	18,700	19,700	25,300	25,400	26,700	27,400	28,200	29,400
600	12,700	13,800	14,800	15,900	16,900	17,600	18,100	19,100	20,200	21,200	27,000	27,600	28,000	29,100	30,200	31,300
700	13,500	14,600	15,900	17,100	18,300	19,100	19,700	20,600	21,800	23,200	28,900	29,600	30,200	31,300	32,600	33,800
800	14,200	15,400	16,900	18,300	19,500	20,600	21,400	22,100	23,500	24,900	30,900	31,500	32,100	33,400	34,700	36,200
900	15,000	16,700	17,700	19,300	20,800	21,600	22,500	23,500	25,100	26,600	32,600	33,600	34,000	35,500	36,900	38,300
1,000	15,600	17,700	18,700	20,400	22,100	22,700	23,300	24,900	26,600	28,000	34,200	35,200	35,800	37,500	39,000	40,400
1,100	16,600	18,500	19,700	21,600	23,300	24,000	24,900	26,600	28,200	29,900	36,200	37,100	37,900	39,600	41,300	43,100
1,200	17,000	18,900	20,600	22,500	23,900	25,000	25,800	27,800	29,500	31,400	37,700	38,500	39,400	41,300	42,900	45,400
1,300	17,900	19,700	21,600	23,800	25,400	26,400	27,400	29,300	31,000	32,900	39,400	40,400	41,300	43,300	45,200	47,000
1,400	18,500	20,600	22,500	24,600	26,500	27,500	28,500	30,600	32,400	34,300	41,200	42,100	42,900	45,200	47,000	48,900
1,500	19,300	21,400	23,500	25,600	29,100	30,100	32,200	34,300	36,400	38,100	42,900	44,100	45,000	47,300	49,400	51,500
1,600	20,000	22,300	24,600	26,700	30,300	32,400	35,800	38,100	40,400	41,900	44,900	46,200	47,100	49,400	51,700	53,800
1,700	20,800	23,100	25,600	27,800	31,400	33,900	37,300	39,600	41,900							
1,800	21,400	23,900	26,400	28,800	31,700	35,000	38,500	40,800	43,400							

ブラック・ホワイト・ステンカラー

W \ H	500	600	700	800	900	1,000	1,100	1,200	1,300	1,400	1,500	1,600	1,700	1,800	1,900	2,000
400	11,500	12,600	13,400	14,400	15,000	15,200	16,000	16,500	17,800	18,800	24,400	25,000	25,500	26,400	28,500	29,500
500	12,600	13,400	14,500	15,400	16,500	17,000	17,400	18,300	19,400	20,500	26,300	26,400	27,800	28,500	29,300	30,600
600	13,200	14,400	15,400	16,500	17,600	18,300	18,800	19,900	21,000	22,000	28,100	28,700	29,100	30,300	31,400	32,600
700	14,000	15,200	16,500	17,800	19,000	19,900	20,500	21,400	22,700	24,100	30,100	30,800	31,400	32,600	33,900	35,200
800	14,800	16,000	17,600	19,000	20,300	21,400	22,300	23,000	24,400	25,900	32,100	32,800	33,400	34,700	36,100	37,600
900	15,600	17,400	18,400	20,100	21,600	22,500	23,400	24,400	26,100	27,700	33,900	34,900	35,400	36,900	38,400	39,800
1,000	16,200	18,400	19,400	21,200	23,000	23,600	24,200	25,900	27,700	29,100	35,600	36,600	37,200	39,000	40,600	42,000
1,100	17,300	19,200	20,500	22,500	24,200	25,000	25,900	27,700	29,300	31,100	37,600	38,600	39,400	41,200	43,000	44,800
1,200	17,700	19,700	21,400	23,400	24,900	26,000	26,800	28,900	30,700	32,700	39,200	40,000	41,000	43,000	44,600	47,200
1,300	18,600	20,500	22,500	24,800	26,400	27,500	28,500	30,500	32,200	34,200	41,000	42,000	43,000	45,000	47,000	48,900
1,400	19,200	21,400	23,400	25,600	27,600	28,600	29,600	31,800	33,700	35,700	42,800	43,800	44,600	47,000	48,900	50,900
1,500	20,100	22,300	24,400	26,600	30,300	31,300	33,500	35,700	37,900	39,600	44,600	45,900	46,800	49,200	51,400	53,600
1,600	20,800	23,200	25,600	27,800	31,500	33,700	37,200	39,600	42,000	43,600	46,700	48,000	49,000	51,400	53,800	56,000
1,700	21,600	24,000	26,600	28,900	32,700	35,300	38,800	41,200	43,600							
1,800	22,300	24,900	27,500	30,000	33,000	36,400	40,000	42,400	45,100							

(アルミブラケット付) * ステンブラケット別売

* 特寸 最大W5500×H5400まで製作出来ます。

(注意) 表示価格は製品価格で運搬費、現場採寸費、取付費、消費税は含まれておりません。

【四方枠立格子】 ※横格子タイプ有

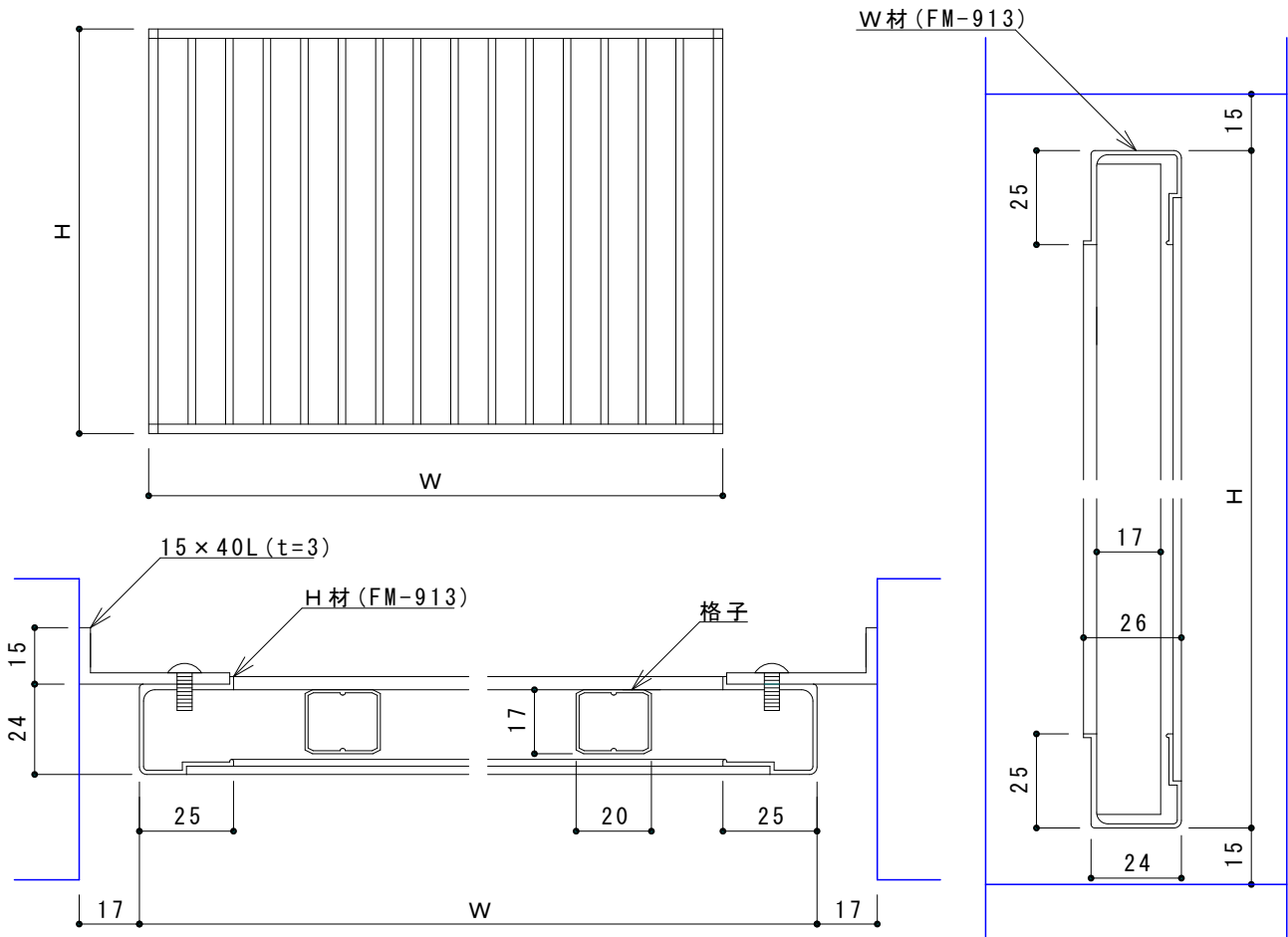

(ベランダ開口用)

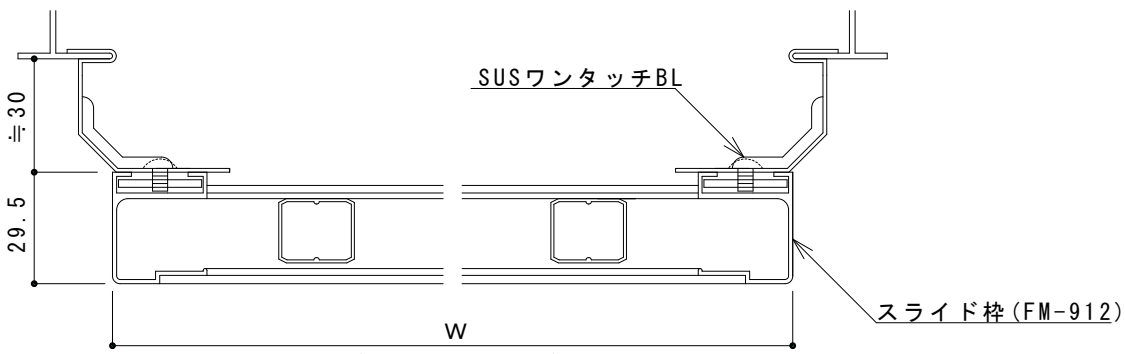

(※ヒレ内々寸法)

(面格子用)

(使用型材)

W、H材 (FM-913)	スライド枠 (FM-912)	格子

(カラーバリエーション) シルバー、ブロンズ、ブラック、ステンカラー、ホワイト

四方枠たて格子 定 価 表

シルバー・ブロンズ

W H	500	600	700	800	900	1,000	1,100	1,200	1,300	1,400	1,500	1,600	1,700	1,800	1,900	2,000
400	9,000	9,900	10,800	11,400	12,000	12,400	12,800	13,200	14,300	15,000	19,500	20,000	20,400	21,100	22,800	23,500
500	9,900	10,600	11,600	12,300	13,200	13,500	13,900	14,700	15,000	16,400	21,000	21,500	22,200	22,800	23,500	24,600
600	10,400	11,300	12,300	13,200	14,100	14,700	15,000	15,900	16,800	17,600	22,400	23,000	23,300	24,200	25,200	26,400
700	11,100	12,000	13,100	14,300	15,100	16,000	16,400	17,100	18,200	19,300	24,000	24,700	25,200	26,000	27,100	28,100
800	11,700	12,700	14,100	15,200	16,300	17,100	17,700	18,300	19,500	20,700	25,700	26,100	26,700	27,700	28,800	30,100
900	12,400	13,700	14,800	16,100	17,300	18,000	18,700	19,500	20,900	22,100	27,100	27,900	28,200	29,500	30,700	31,800
1,000	12,800	14,600	15,500	16,900	18,400	18,800	19,400	20,700	22,100	23,300	28,500	29,300	29,800	31,200	32,300	33,600
1,100	13,700	15,100	16,400	18,000	19,400	20,000	20,700	22,100	23,500	24,800	30,100	30,800	31,500	32,900	34,300	35,700
1,200	14,100	15,500	17,100	18,700	19,800	20,800	21,400	23,100	24,600	26,100	31,300	32,000	32,800	34,300	35,700	37,000
1,300	14,600	16,200	18,000	19,800	21,000	21,900	22,800	24,400	25,700	27,300	32,800	33,600	34,300	35,900	37,500	39,100
1,400	15,100	16,900	18,700	20,400	22,100	22,900	23,600	25,400	27,000	28,600	34,200	35,000	35,700	38,500	39,100	40,600
1,500	15,900	17,600	19,500	21,300	23,100	25,100	26,700	28,600	30,200	31,700	35,600	36,600	37,500	39,300	41,100	42,700
1,600	16,400	18,300	20,600	22,100	24,200	26,100	29,700	31,700	33,600	34,900	37,400	38,300	39,200	41,000	42,900	44,600
1,700	17,000	18,900	21,300	23,100	25,200	28,200	31,100	32,900	35,000							
1,800	17,500	18,600	21,900	23,900	26,100	29,100	32,000	33,900	36,000							

ブラック・ホワイト・ステンカラー

W H	500	600	700	800	900	1,000	1,100	1,200	1,300	1,400	1,500	1,600	1,700	1,800	1,900	2,000
400	9,900	10,900	11,900	12,500	13,200	13,600	14,100	14,500	15,700	16,500	21,500	22,000	22,400	23,200	25,100	25,900
500	10,900	11,700	12,800	13,500	14,500	14,900	15,300	16,200	17,000	18,000	23,100	23,700	24,400	25,100	25,900	27,100
600	11,400	12,400	13,500	14,500	15,500	16,200	16,500	17,500	18,500	19,400	24,600	25,300	25,600	26,600	27,700	27,800
700	12,200	13,200	14,400	15,700	16,600	17,600	18,000	18,800	20,000	21,200	26,400	27,200	27,700	28,600	29,800	30,900
800	12,900	14,000	15,500	16,700	17,900	18,800	19,500	20,100	21,500	22,800	28,300	28,700	29,400	30,500	31,700	33,100
900	13,600	15,100	16,300	17,700	19,000	19,800	20,600	21,500	23,000	24,300	29,800	30,700	31,000	32,500	33,800	35,000
1,000	14,100	16,100	17,100	18,600	20,200	20,700	21,300	22,800	24,300	25,600	31,400	32,200	32,800	34,300	35,500	37,000
1,100	15,100	16,600	18,000	19,800	21,300	22,000	22,800	24,300	25,900	27,300	33,100	33,900	34,700	36,200	37,700	39,300
1,200	15,500	17,100	18,800	20,600	21,800	22,900	23,500	25,400	27,100	28,700	34,400	35,200	36,100	37,700	39,300	41,400
1,300	16,100	17,800	19,800	21,800	23,100	24,100	25,100	26,800	28,300	30,000	36,100	37,000	37,700	39,500	41,300	43,000
1,400	16,600	18,600	20,600	22,400	24,300	25,200	26,000	27,900	29,700	31,500	37,600	38,500	39,300	42,400	43,000	44,700
1,500	17,500	19,400	21,500	23,400	25,400	27,600	29,400	31,500	33,200	34,900	39,200	40,300	41,300	43,200	45,200	47,000
1,600	18,000	20,100	22,700	24,300	26,600	28,700	32,700	34,900	37,000	38,400	41,100	42,100	43,100	45,100	47,200	49,100
1,700	18,700	20,800	23,400	25,400	27,700	31,000	34,200	36,200	38,500							
1,800	19,300	20,500	24,100	26,300	28,700	32,000	35,200	37,300	39,600							

(アルミブラケット付) * ステンブラケット別売

* 特寸 最大W5500×H5400まで製作出来ます。

(注意) 表示価格は製品価格で運搬費、現場採寸費、取付費、消費税は含まれておりません。

【ヘダテ】 ※集合住宅のベランダ間仕切り

【 縦断面詳細図 】

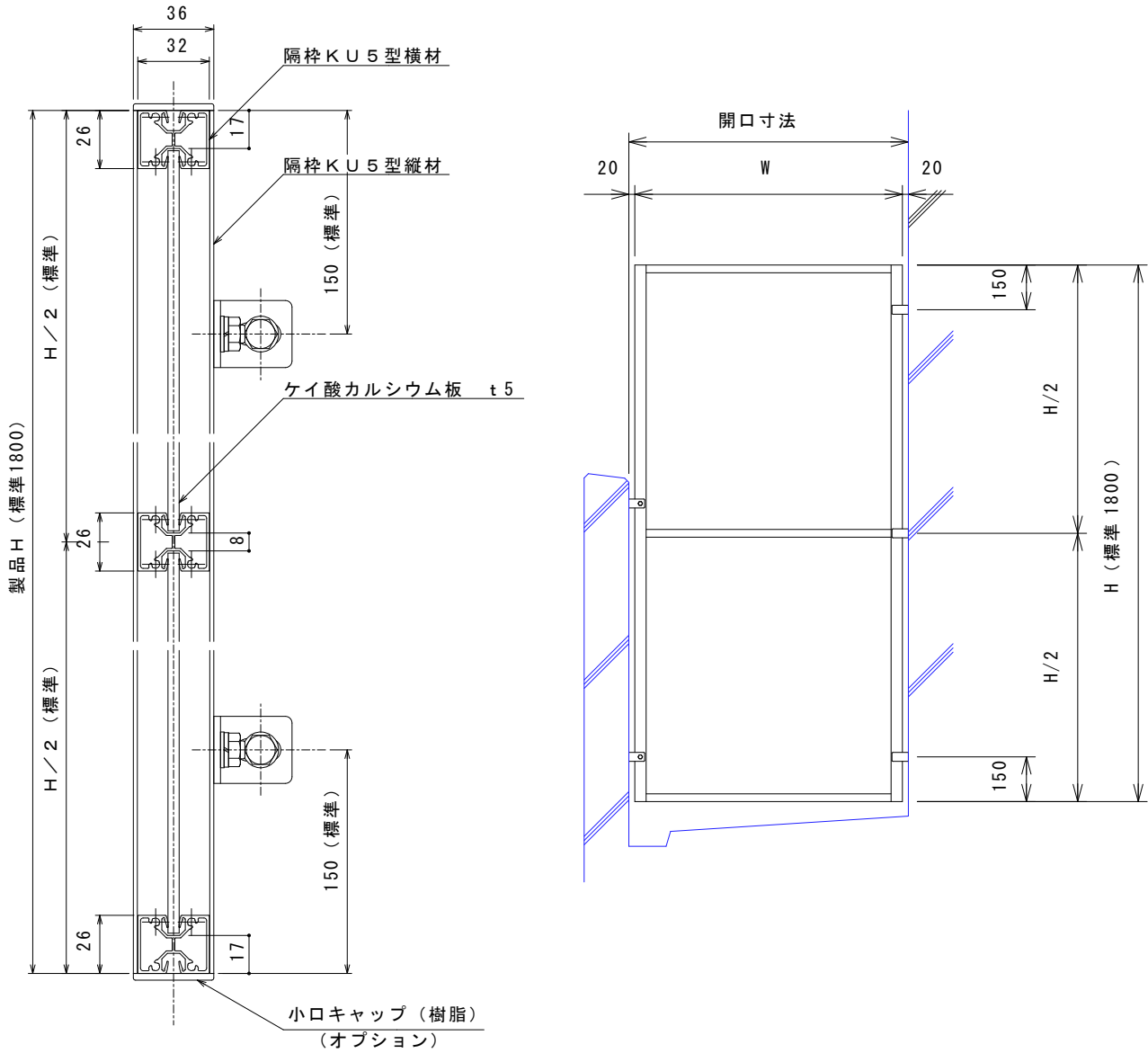

【 横断面詳細図 】

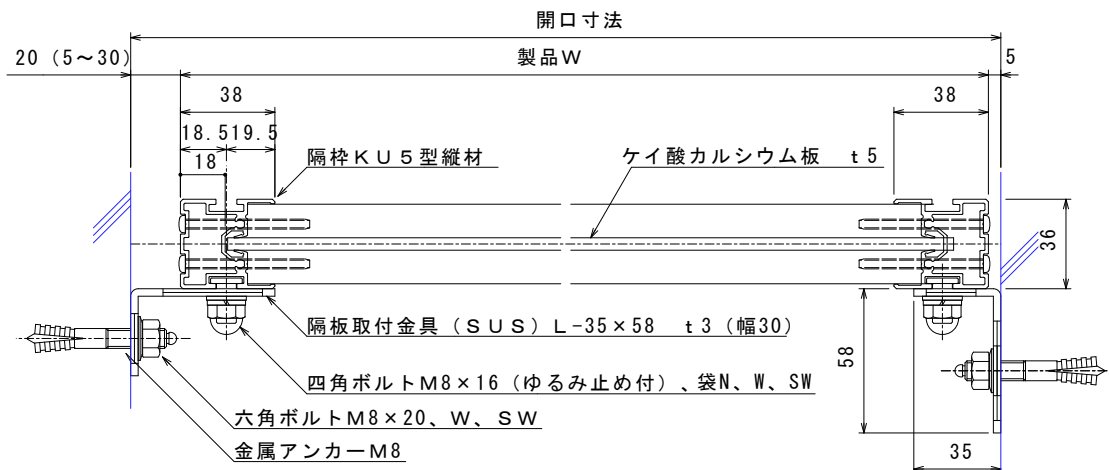

【オーダー門扉】

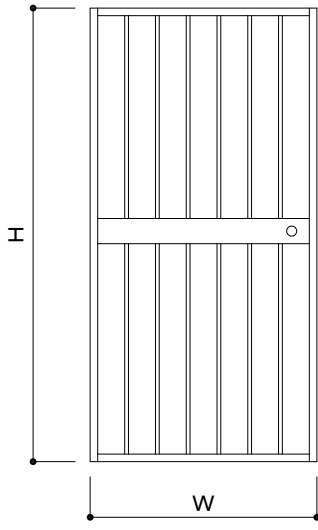

(立格子タイプ)

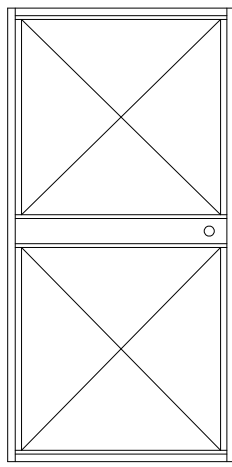

(パネルタイプ)

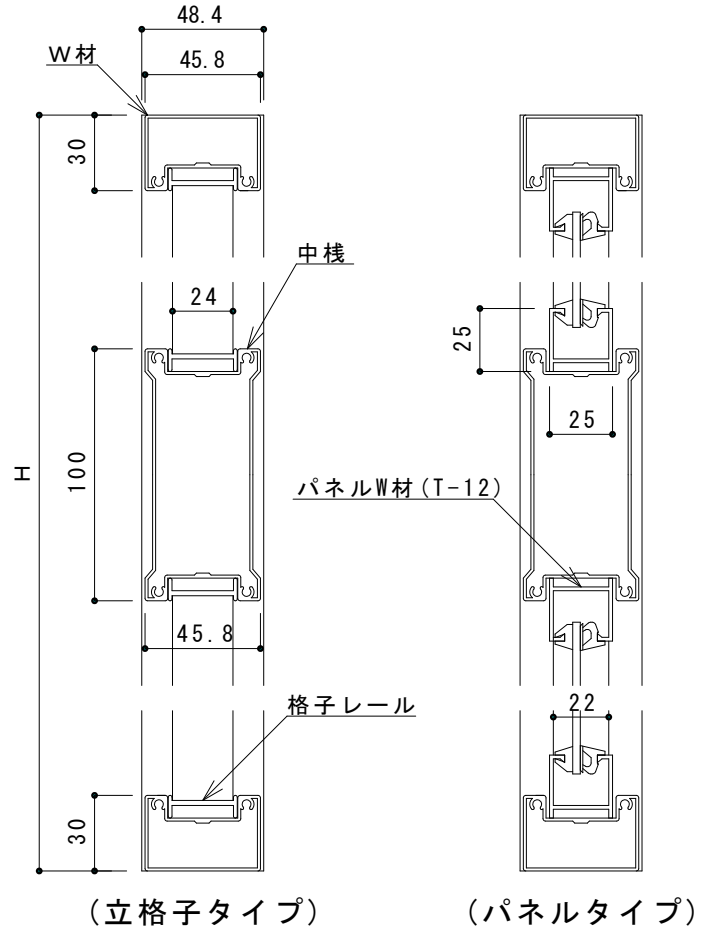

(立格子タイプ)

(パネルタイプ)

(立格子タイプ)

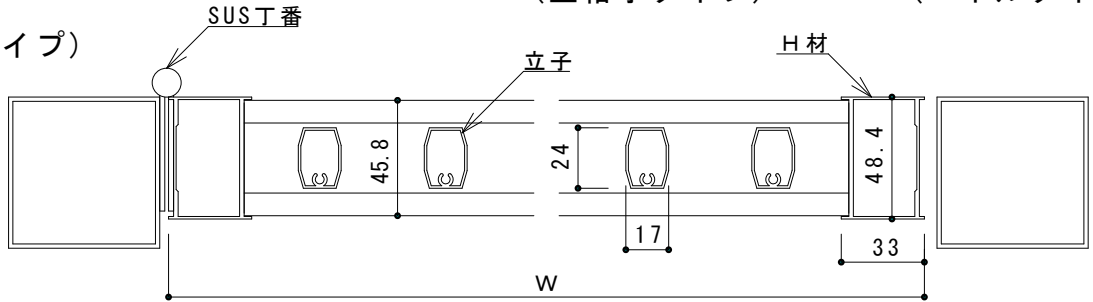

(パネルタイプ)

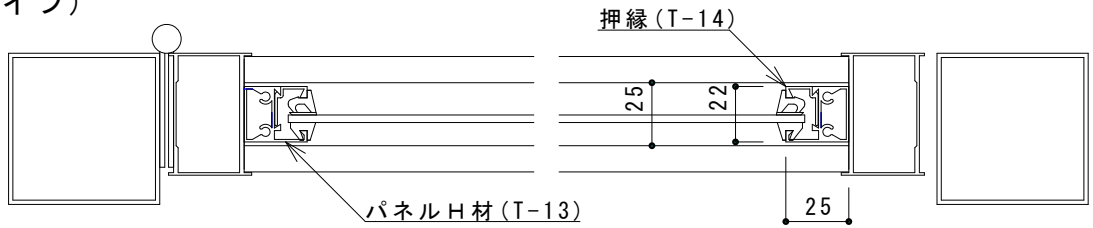

(使用型材)

W材	H材	中棧	格子レール
立子	パネルW材 (T-12)	パネルH材 (T-13)	パネル押縁 (T-14)

【納骨堂取替え用扉】

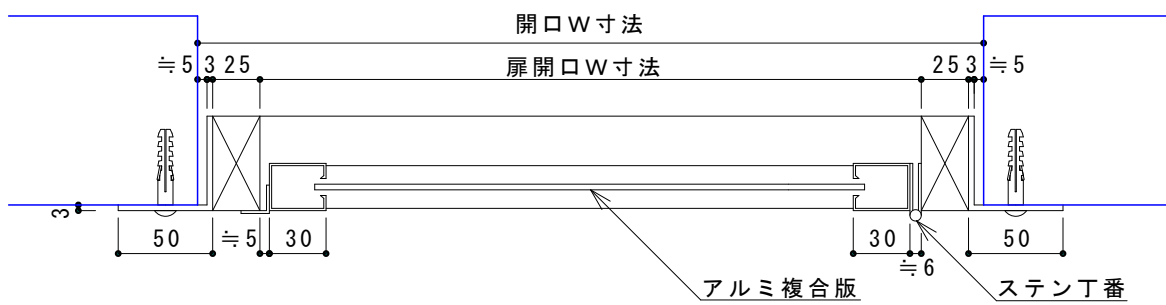
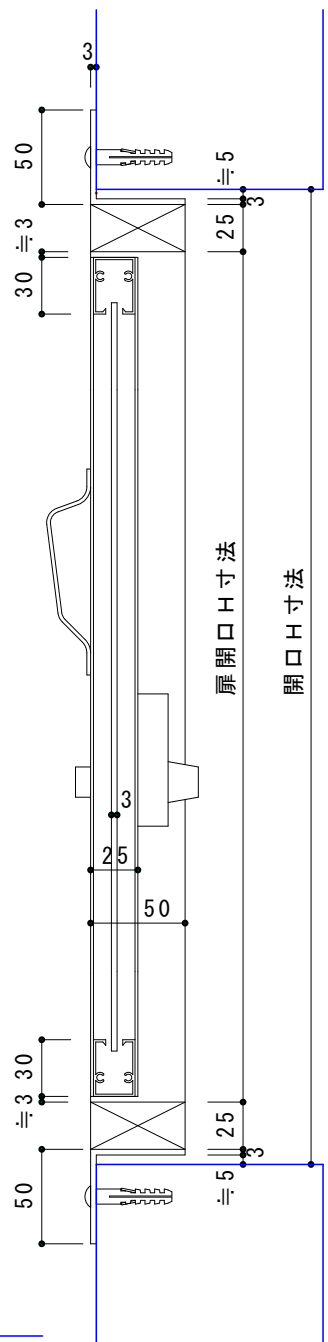
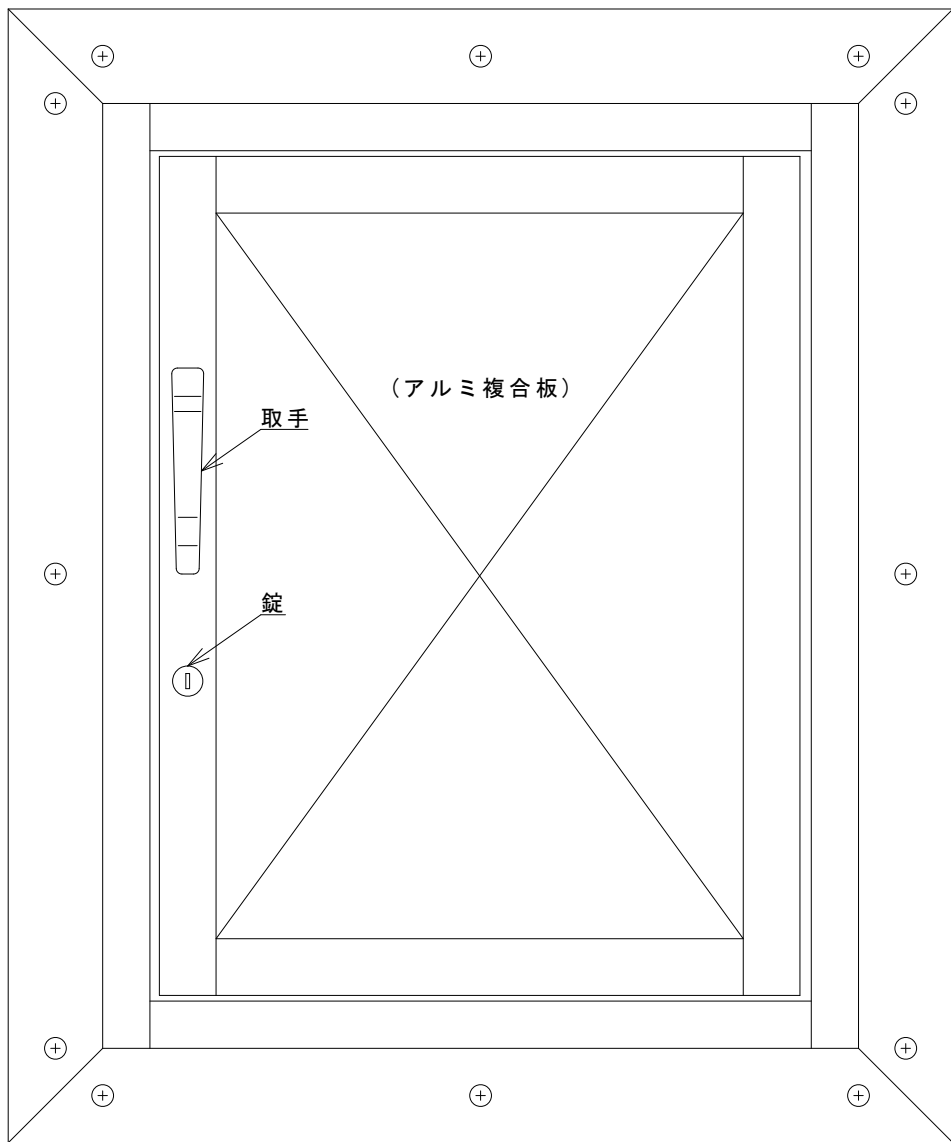

【BL窓手摺】

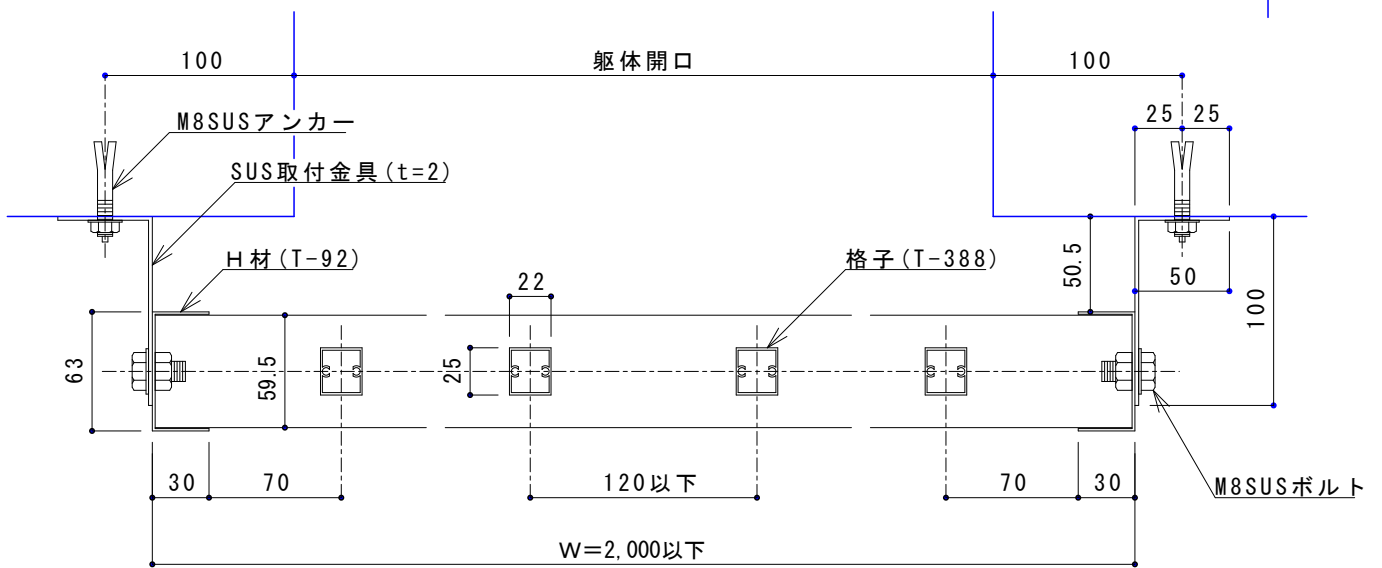
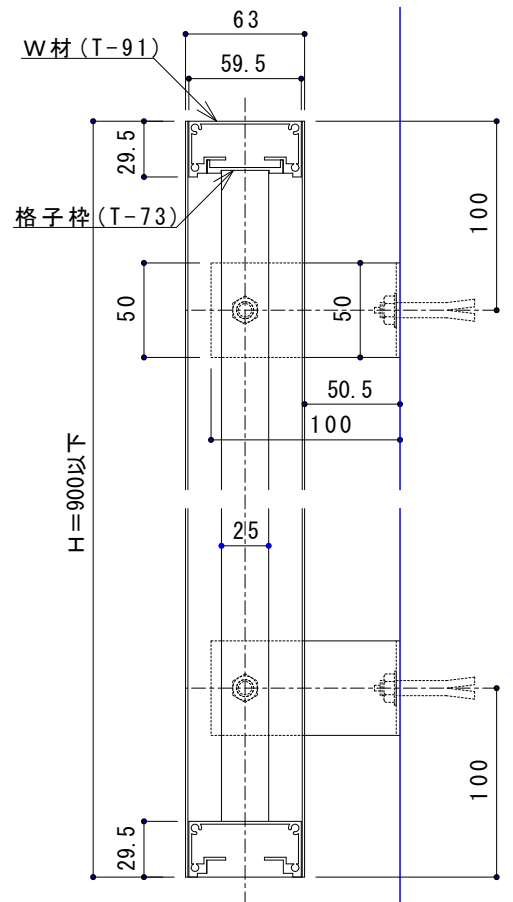
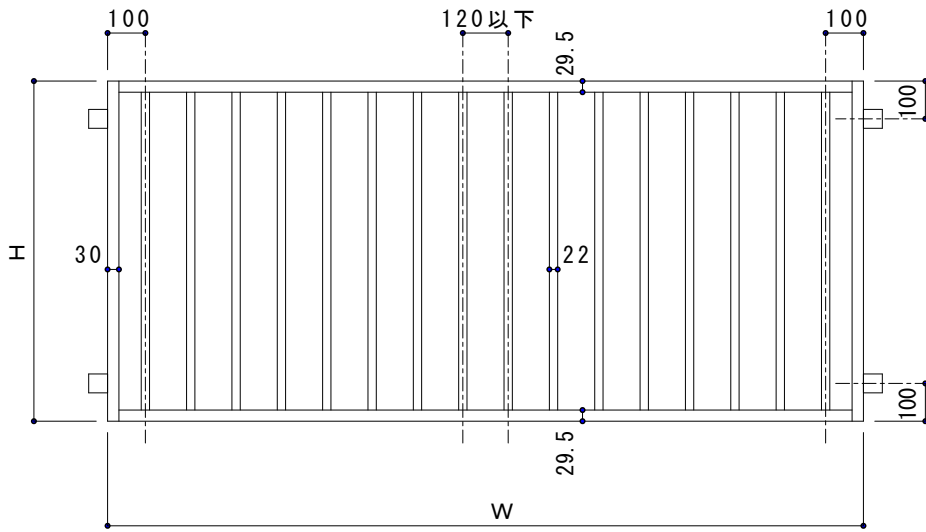

(使用型材)

W材 (T-91)	H材 (T-92)	格子枠 (T-73)	格子 (T-388)

(カラーバリエーション) シルバー

【パラストレ型手摺】 ※BL仕様有

(立格子タイプ)

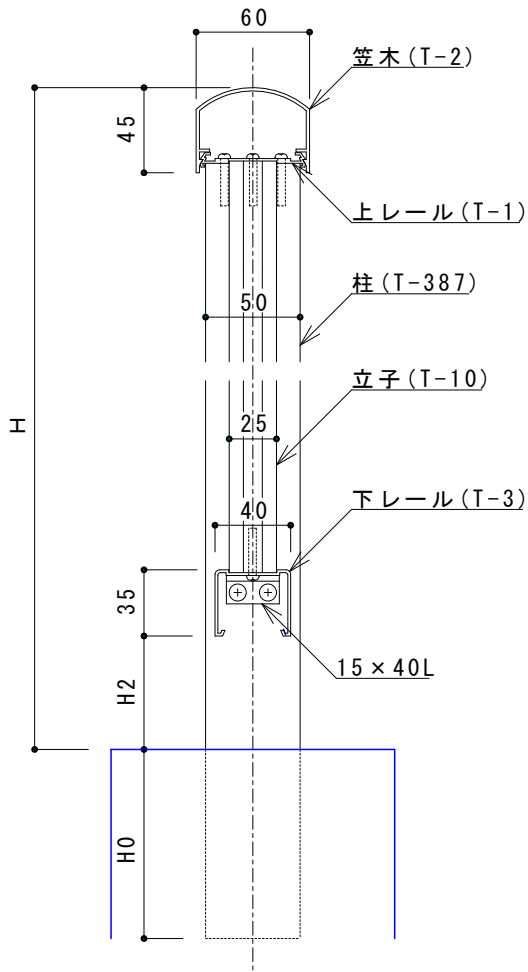

(パネルタイプ)

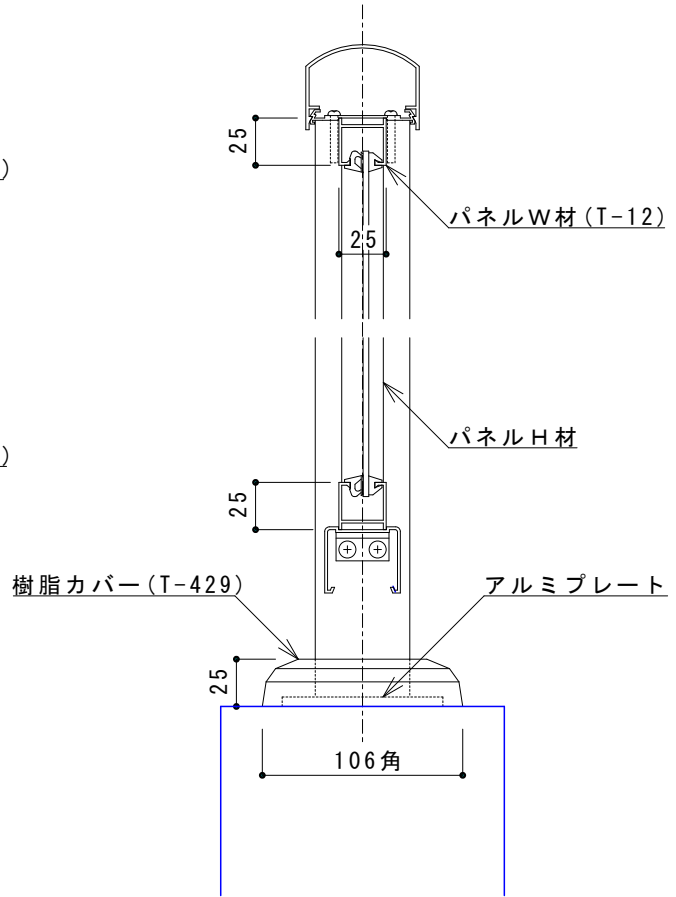

(柱埋め込み式)

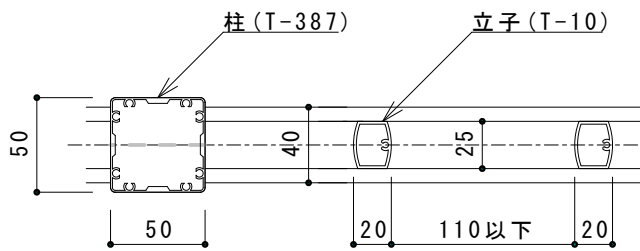

(柱プレート式)

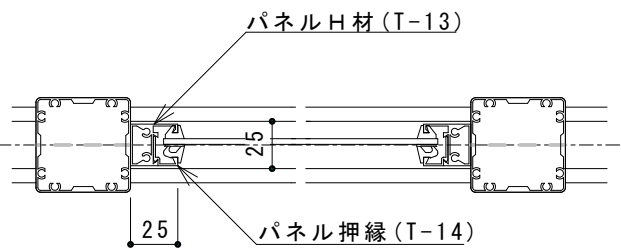

(使用型材)

笠木 (T-2) 	上レール (T-1) 	下レール (T-3) 	下レールカバー (T-391) 	50角UB柱 (T-387)
パネルW材 (T-12) 	パネルH材 (T-13) 	パネル押縁材 (T-14) 	立子 (T-10) 	立子 (T-388)

(カラーバリエーション) シルバー、ダークブロンズ、ブラック、ステンカラー

(デザインバリエーション)

1段笠木 格子タイプ 	1段笠木 パネルタイプ
2段笠木 格子タイプ 	2段笠木 パネルタイプ

パンチングパターン

丸穴60°千鳥

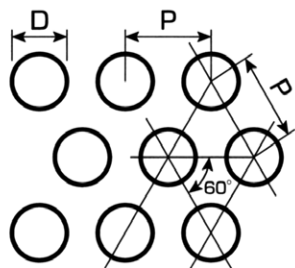

$$\frac{90 \times D^2}{P^2} = \text{開孔率(\%)}$$

丸穴45°千鳥

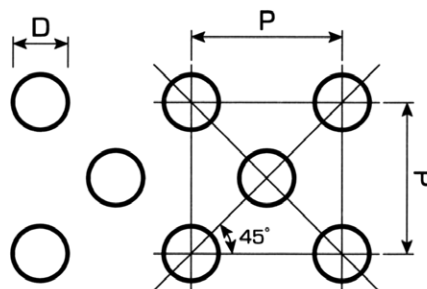

$$\frac{157 \times D^2}{P^2} = \text{開孔率(\%)}$$

丸穴並列

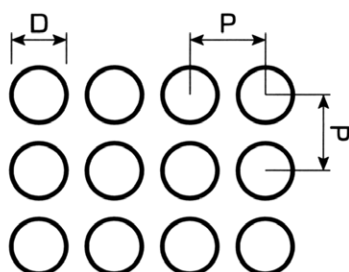

$$\frac{78.5 \times D^2}{P^2} = \text{開孔率(\%)}$$

角穴並列

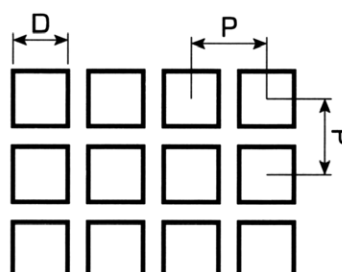

$$\frac{100 \times D^2}{P^2} = \text{開孔率(\%)}$$

パンチングタイプ

順型

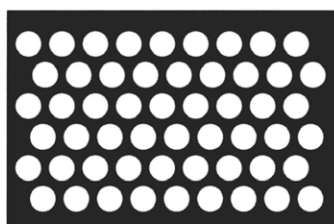

順型

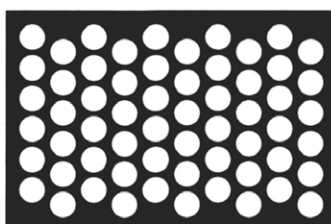

トビ型

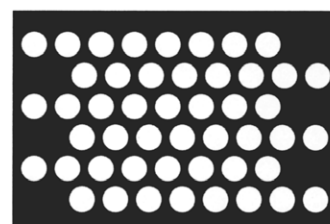

●ご照会、ご注文方法は、下記の要領にて御指示下さい。

- | | |
|------------------|-----------------------|
| 1 材料の種類 | (アルミ、ステンレス、鉄、他、養生の有無) |
| 2 製品寸法 | (板厚、巾、長さ) |
| 3 カタログNo. | (穴径、ピッチ、抜きパターン) |
| 4 フチ残し | |
| 5 その他加工 | (焼付、アルマイト、折曲、R加工 他) |
| 6 数量 | |
| 7 ご希望納期 | |

No.318

D/4.0 P/7.0 (29.3%)

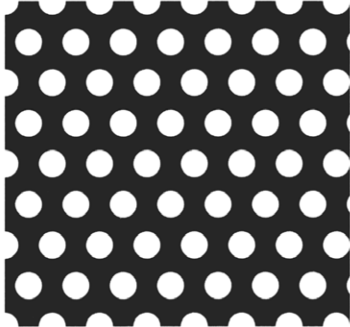

No.322

D/5.0 P/8.0 (35.1%)

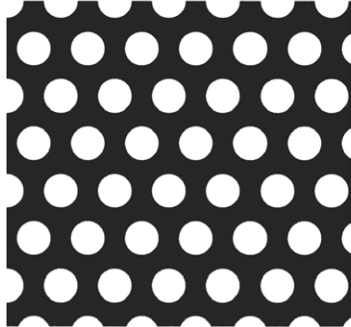

No.323

D/5.0 P/10.0 (22.5%)

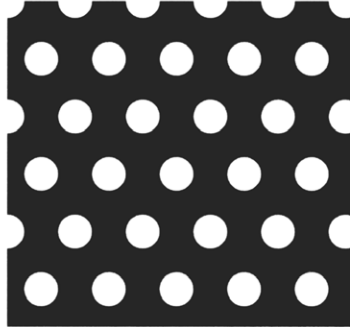

No.325

D/6.0 P/9.0 (40.0%)

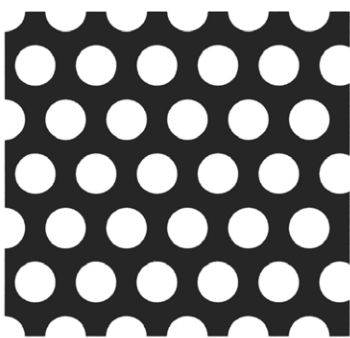

No.326

D/6.0 P/10.0 (32.4%)

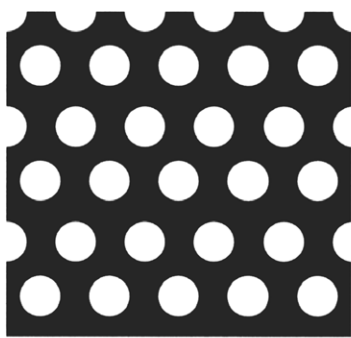

No.327

D/7.0 P/10.0 (44.1%)

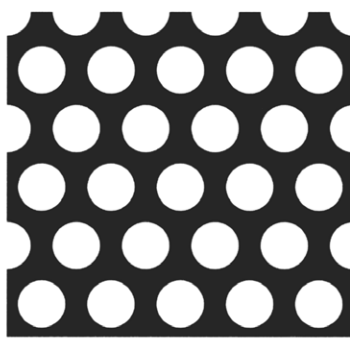

No.329

D/8.0 P/12.0 (40.0%)

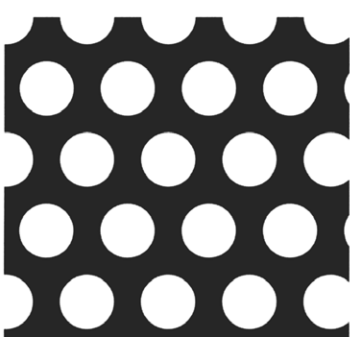

No.332

D/10.0 P/15.0 (40.0%)

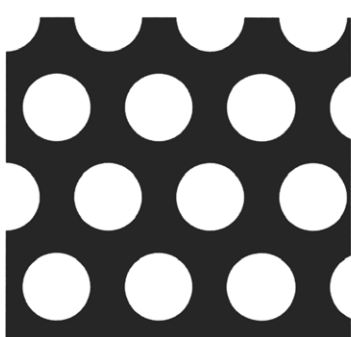

No.333

D/10.0 P/16.0 (35.1%)

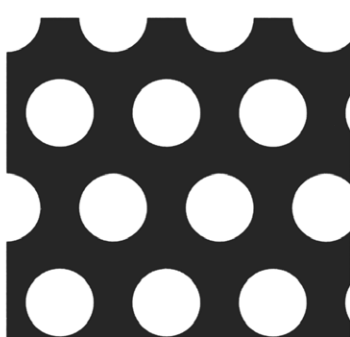

本カタログ以外の仕様につきましても多数用意しておりますのでお問い合わせください。

No.355

角/6.0 P/9.0 (44.4%)

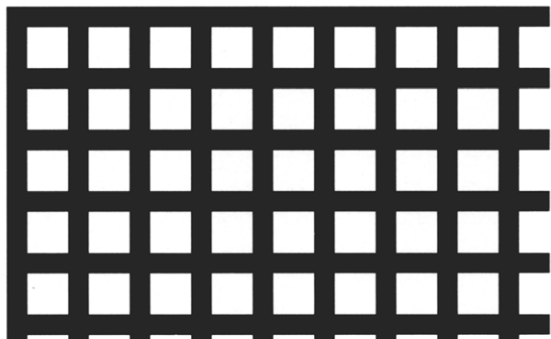

No.357

角/10.0 P/15.0 (44.4%)

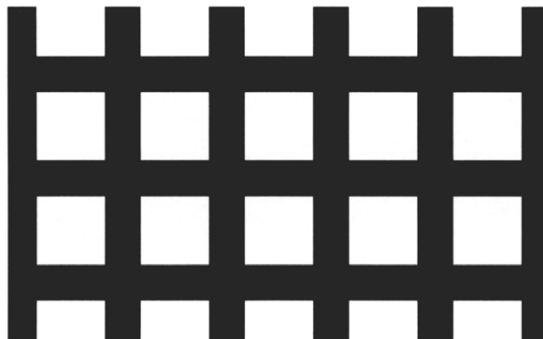

No.375

D/5.0 P/10.0 (19.6%)

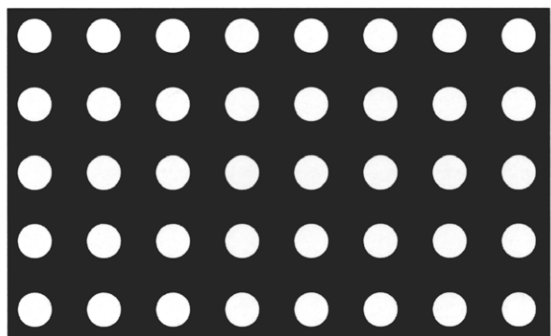

No.376

D/6.0 P/10.0 (28.3%)

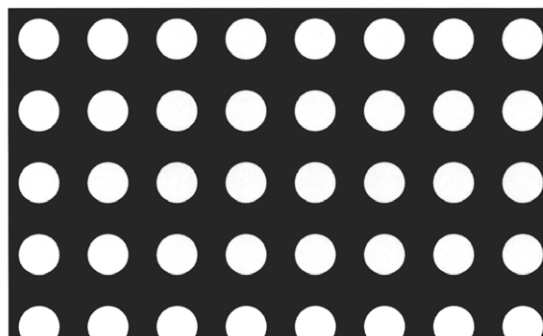

No.377

D/8.0 P/12.0 (34.9%)

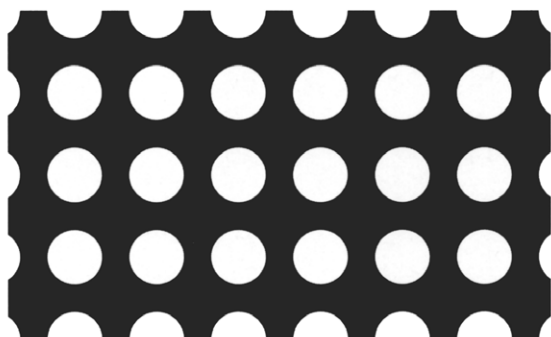

No.378

D/10.0 P/15.0 (34.9%)

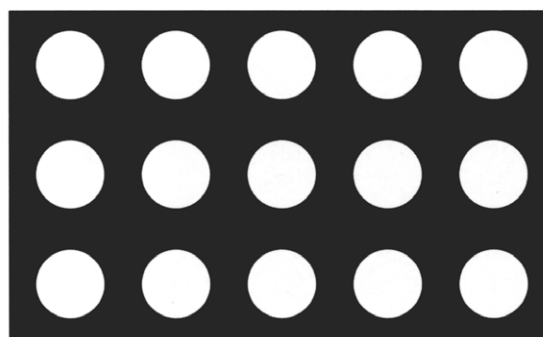

本カタログ以外の仕様につきましても多数用意しておりますのでお問い合わせください。

【オーダー製作品集】

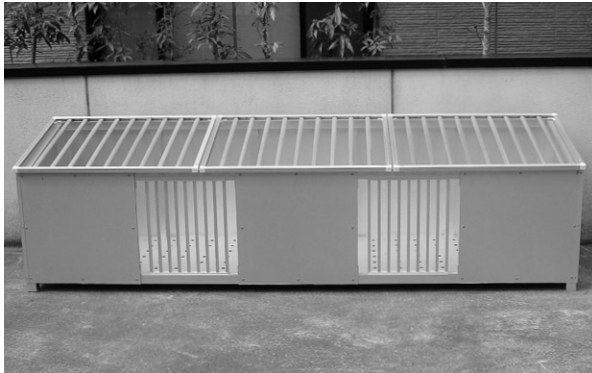

ダストボックス



納骨堂扉



ドックケージ



ドックケージ2



喫煙所

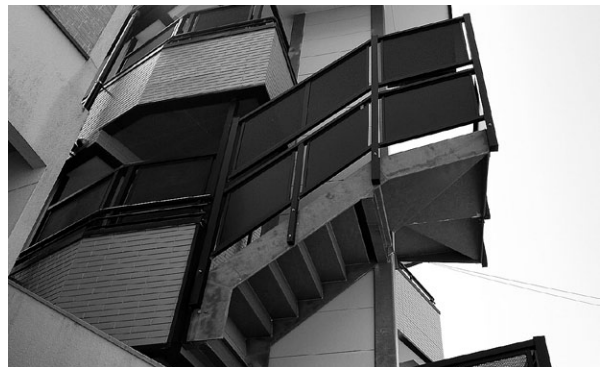

目隠し1



目隠し2



目隠し3

株式会社 **キョーリツ** 製作所

事務所 〒781-5102 高知市大津甲123
TEL (088) 866-7773 (代)
FAX (088) 866-7244

工場 〒783-0007 南国市明見114
TEL (088) 864-4677 (代)

メールアドレス kyoritu.al@helen.ocn.ne.jp

